

THE BREEZE®

Domestic and Export Instruction Manual

Models 3030, 3030SR, 3030EX, 3040, 3040SR









 **GOLD MEDAL®**

FUNFOOD EQUIPMENT & SUPPLIES

Cincinnati, OH 45241-4807 USA

Safety Precautions

	<p style="text-align: center;">⚠ DANGER</p> <p>Machine MUST be properly grounded to prevent electrical shock to personnel. Do NOT immerse the equipment in water. Do NOT use excessive water for cleaning. Unplug your machine before cleaning or servicing.</p>
	<p style="text-align: center;">⚠ DANGER</p> <p>Improper installation, adjustment, alteration, service or maintenance can cause property damage, injury, or death. Read the Installation, Operating, and Maintenance Instructions thoroughly before installing or servicing this equipment.</p>
	<p style="text-align: center;">⚠ WARNING</p> <p>Floss head rotates at 3450 RPM. Operator MUST keep hands and face clear of the floss head to avoid possible injury. Keep all spectators at a reasonable distance, and use a Floss Bubble for added customer protection.</p>
	<p style="text-align: center;">⚠ WARNING</p> <p>Keep all foreign objects out of floss head. To avoid possible eye injury, do not fill floss head with sugar while the head is on and rotating.</p>
	<p style="text-align: center;">⚠ CAUTION</p> <p>Do NOT allow direct contact with this equipment and the general public when used in food service locations. Only personnel that are trained and familiar with the equipment should operate the equipment. Carefully read all installation instructions before operation.</p>
	<p style="text-align: center;">⚠ CAUTION</p> <p>This machine is NOT to be operated by minors. Minors are classified as anyone under the age of 18.</p>

NOTE

Improvements are always being made to Gold Medal Products equipment. This information may not be the latest available for your purposes. It is critical that you call Gold Medal Products technical service department at 1-800-543-0862 for any questions about machine operations, replacement parts, or any service questions.

Installation Instructions

Inspection of Shipment:

After unpacking, check thoroughly for any damage which may have occurred in transit. Claims should be filed immediately with the transportation company. The warranty does not cover damage that occurs in transit or damage caused by abuse or consequential damage due to the operation of this machine, since it is beyond our control.

Your Floss Machine warranty is described on the back page of this manual. This does NOT cover the motor bearings, since they can be damaged by the operator.

Electrical Requirements:

The following power supply must be provided:

Model No. 3030, 3030SR, 3040 and 3040SR:	120 VAC, 60 Hz, 15 Amps
Model No. 3030EX:	240 VAC, 50 Hz, 15 amps

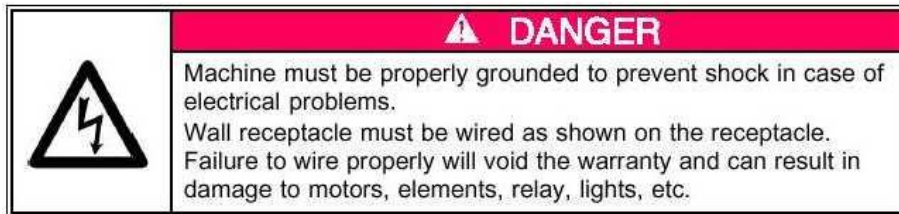

Your electrician must furnish sufficient current for proper machine operation. We recommend this floss machine be on a dedicated and circuit protected line. Failure to wire properly will void the warranty and can result in damage to the heat elements, motor and etc.

It is Gold Medal Products Company's recommendation that this machine be plugged directly into a wall outlet. The use of extension cords is not recommended due to safety concerns and the floss machine's performance may be sacrificed/reduced.

Before You Plug in Machine

Remove all padding and restraints.

Turn the two shipping knobs located around the motor mount casting counter-clockwise. This will allow the motor mount casting to "float" freely on the springs. **Note:** This step is not necessary for the 3040SR.

Operating Instructions

Controls and their Functions:

Main Switch - Turns motor "on" or "off" and supplies voltage to the heat switch.

Heat Switch - Turns voltage to the heating element "on" or "off."

Heat Control (except Accu-Breeze)- Increases or decreases voltage to heating element using a graduated dial.

Sugar for Your Cotton Candy

The easiest way to make sure you have the right texture sugar, with proper flavor and colors, is to use GOLD MEDAL FLOSSUGAR. FLOSSUGAR gives good, rich colors and flavors, and does not exceed the color limitations imposed by the Food and Drug Administration. FLOSSUGAR comes in sealed, plastic-coated cartons with handy pouring spouts for filling. If you use your own flavors in cotton candy, make sure they are not gum or starch based; these materials burn on the ribbons.

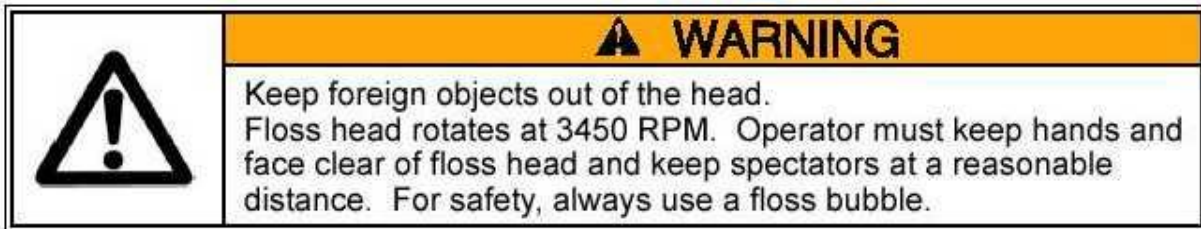

Heat Control Setting Test

1. Follow the guidelines described on page 3 for supplying power to machine.
2. With main switch still OFF, fill floss head. Always fill it 90% full with sugar. This 90% level is necessary to obtain a balanced condition in the floss head. **DO NOT OVERFILL!** Excessive vibration will occur if overfilled. Before turning the power on, manually turn the head to balance out the sugar. This will eliminate excessive vibration of the head.
3. Turn MAIN SWITCH and HEAT SWITCH "ON." **Note:** Steps 4 – 8 do not apply to the 3040 or 3040SR.
4. Turn heat control knob clockwise to maximum setting to initiate the fastest possible warm up.
5. The machine should start making floss in about 45 seconds. When the unit starts making floss, you must reduce the heat setting. Turn the heat control knob counter clockwise to eliminate smoking.
6. Once you find the ideal setting for the HEAT CONTROL, operate with the setting near this position each time.
7. When finished making floss, run the floss head completely empty of sugar.
8. Turn the heat control dial to the maximum position, and allow the machine to run for approximately 3-4 minutes. This will burn any excess sugar out of the head, and prevent any excess carbon build- up.
9. Turn the heat switch "off" and allow the motor to run for 1-2 minutes to allow the floss head to "cool down".
10. Turn the motor switch off and allow the motor to come to a complete stop.

Installation of Floss Stabilizer

1.

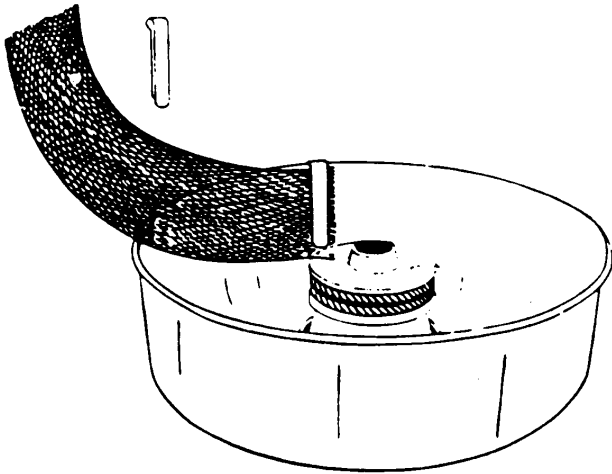

2.

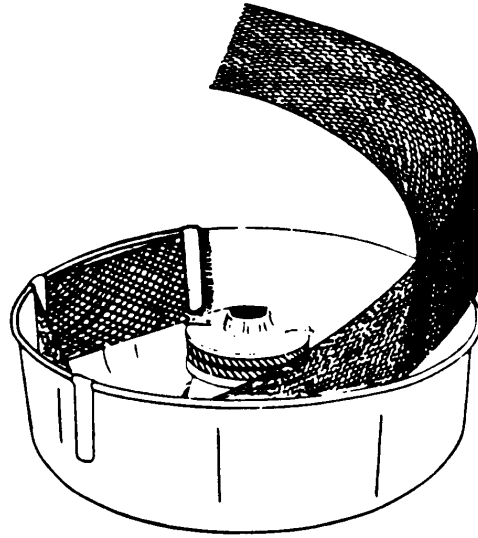

3.

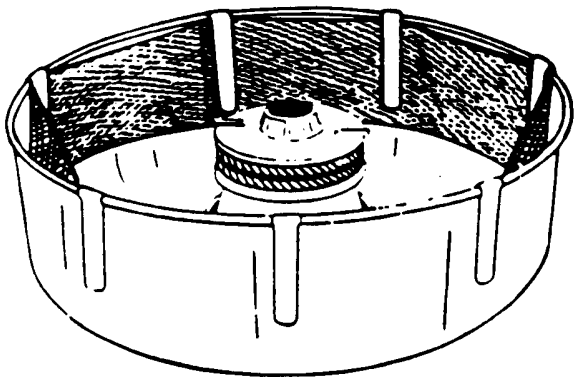

4.

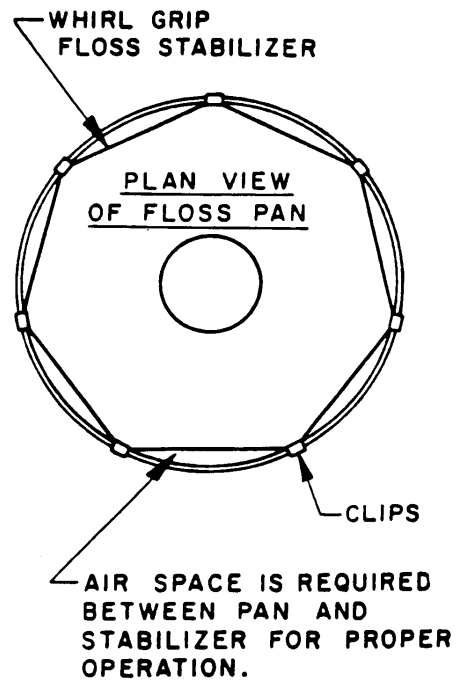

Whirl Grip-Clip Installation Instructions

The whirl grip-clip has been designed to provide better air flow by keeping the whirl grip (netting) off the floss pan.

To install, please follow these simple steps:

1. Insert the hooked side of the clip into the whirl grip-approximately (2) holes down from the top, inserting from the back-as shown below.



2. Push the whirl grip through, leaving about (5) spaces in-between, and re-insert through the back side of the whirl grip.



3. Continue this process with all (6) clips, keeping equal spacing around the pan, and slide the long flat side of the clip down the outside of the floss pan.

Making Floss



Pick a cone; if it sticks in the stack of cones, twist it off the stack.

Hold an inch or two of the pointed end of the cone between two fingers and a thumb. With a light flicking action, roll cone in the web of floss building up in the pan. Lift the cone up with the ring of floss attached and rotate the cone to wrap the floss. **DO NOT** roll floss while the cone is inside the pan. This will pack the floss too tightly.

If the floss fails to stick to the cone, pass the cone near the spinner head to pick up a "starter" of melted sugar. Lift the cone out of the pan and wrap the floss with a "figure eight" movement of the hand. This leaves giant pockets and makes the final product appear larger. Make sure room humidity is not too high, or product will be "heavy".

1. Grip cone as shown.
2. Break into web of floss with the cone.
3. Wind the sugar onto the cone.
4. Lift web of floss from the pan and roll onto the cone.

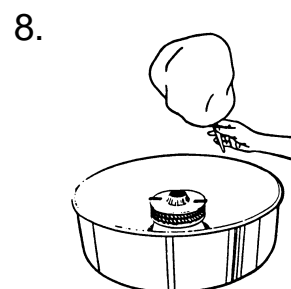
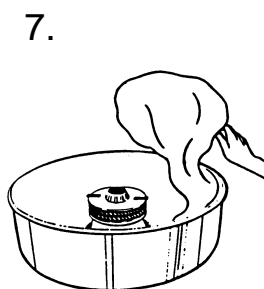
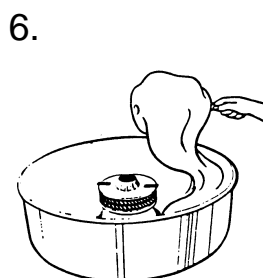
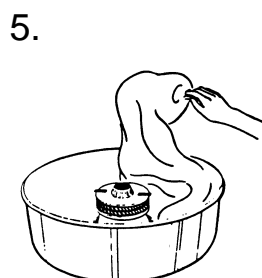
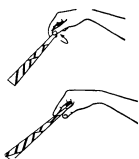

- **DO NOT** put hands or objects in rotating spinner head.
- **DO NOT** fill Spinner Head with sugar while it is rotating.
- Operator should **ALWAYS** wear eye protection.
- **DO NOT** put hands near rotating spinner head.
- Use **ONLY** floss cone to collect cotton candy.



Floater Adjustment

In operation, the floss will collect on the FLOSS STABILIZER. If the floss collects “low” on the stabilizer, twist the front (leading) edge of the leather floaters down. You get more lift and the floss will collect higher.

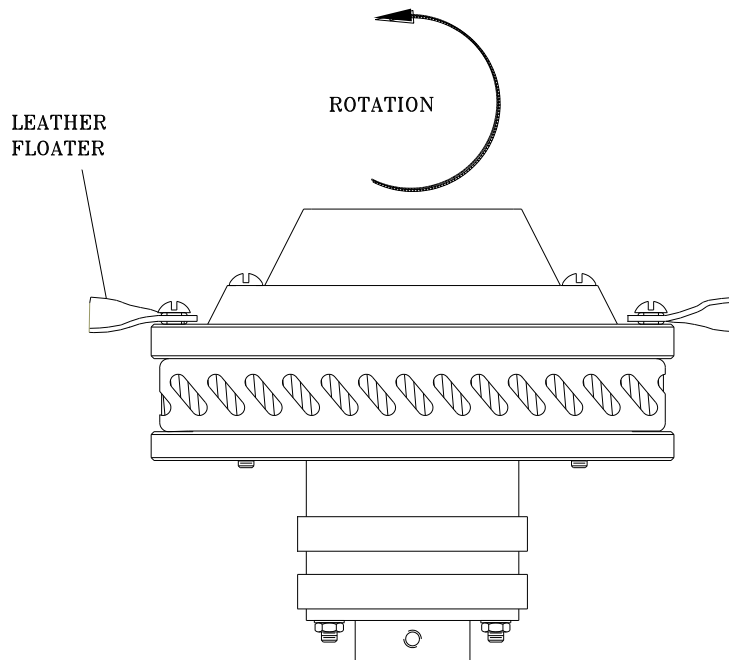
Form leather floaters as shown. This creates a lifting action to float the floss higher on the and outside wall of the floss pan.



MAINTENANCE INSTRUCTIONS

	<p style="text-align: center;">⚠ DANGER</p> <p>Improper installation, adjustment, alteration, service or maintenance can cause property damage, injury, or death. Read the Installation, Operating, and Maintenance Instructions thoroughly before installing or servicing this equipment.</p>
	<p style="text-align: center;">⚠ WARNING</p> <p>Adequate eye protection must be used when servicing this equipment to prevent the possibility of injury.</p>
	<p style="text-align: center;">⚠ CAUTION</p> <p>THE FOLLOWING SECTIONS OF THIS MANUAL ARE INTENDED ONLY FOR QUALIFIED SERVICE PERSONNEL WHO ARE FAMILIAR WITH ELECTRICAL EQUIPMENT. THESE ARE NOT INTENDED FOR THE OPERATOR.</p>

How to Check a Triac: (3040 models only)

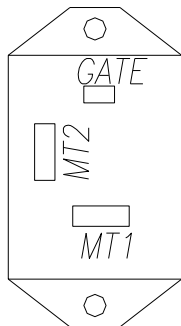

1. Make sure to first unplug the machine.
2. Set the multimeter for ohms or continuity.
3. Disconnect all machine leads from the triac.
4. Connect the positive ohmmeter lead to MT2 and the negative lead to MT1. The ohmmeter should indicate no continuity (OL) through the triac.
5. Using a separate jumper lead, connect the gate of the triac to MT2. The ohmmeter should indicate continuity. (less than 100 ohms)
6. Reconnect the triac so MT1 is connected to the positive ohmmeter lead and the negative lead to MT2. The ohmmeter should indicate no continuity (OL) through the triac.
7. Using a separate jumper lead, connect the gate of the triac to MT2. The ohmmeter should indicate continuity. (less than 100 ohms)

Floss Bands and Elements

Disassembly and Removal

1. Remove all sugar from the head of the machine before disassembling. If the unit is inoperative, carefully turn the machine on its side and shake the sugar out.
2. Remove the four spinner cap retainer screws and spinner cap. In some cases, the sugar can cause the cap and band to stick together. Applying gentle pressure with the heel of your hand should free the parts for removal.
3. Remove the element lead wire retaining screws with a ¼" nut driver and remove the element lead wires from the terminals in the floss head. This will allow the band and element to be removed.
4. Remove the band and element. If there is excessive sugar buildup, soak the band and element in hot water until the sugar dissolves. When the sugar has been removed, allow the band and element to dry over-night.
5. Re-assemble the floss head components, using the above steps for a reference.

Troubleshooting

Excessive Smoke

1. Check heat control setting. After warm up, equipment should make good floss at a reduced setting. Never let the machine operate with the heat so high it produces smoke or if you can smell burned sugar.
2. Check the product mixture being used. For best results, use nothing with a cornstarch base.

Excessive Vibration

1. If the equipment is new, verify that shipping bolts have been loosened and packing materials were removed from the machine.
2. When adding sugar to the floss head, always fill it 90% full to obtain a balanced condition in the head, and eliminate excessive vibration. DO NOT add sugar with motor running!
3. Check for stretched, or uneven suspension springs.
4. Run the sugar completely out, then check for foreign objects or sugar lumps in the head assembly.

ORDERING SPARE PARTS

1. Identify the needed part by checking it against the photos, illustrations, and/or the parts list.
2. When ordering, please include part number, part name, and quantity needed.
3. Please include your model name, serial number, and date of manufacture (located on the machine nameplate) with your order.
4. Address all parts orders to:

Parts Department
Gold Medal Products Co.
10700 Medallion Drive
Cincinnati, Ohio 45241-4807

or, place orders at:
(800) 543-0862
(513) 769-7676
Fax: (513) 769-8500
E-mail: info@gmpopcorn.com
Web Page: www.gmpopcorn.com

Breeze – Cabinet Assembly

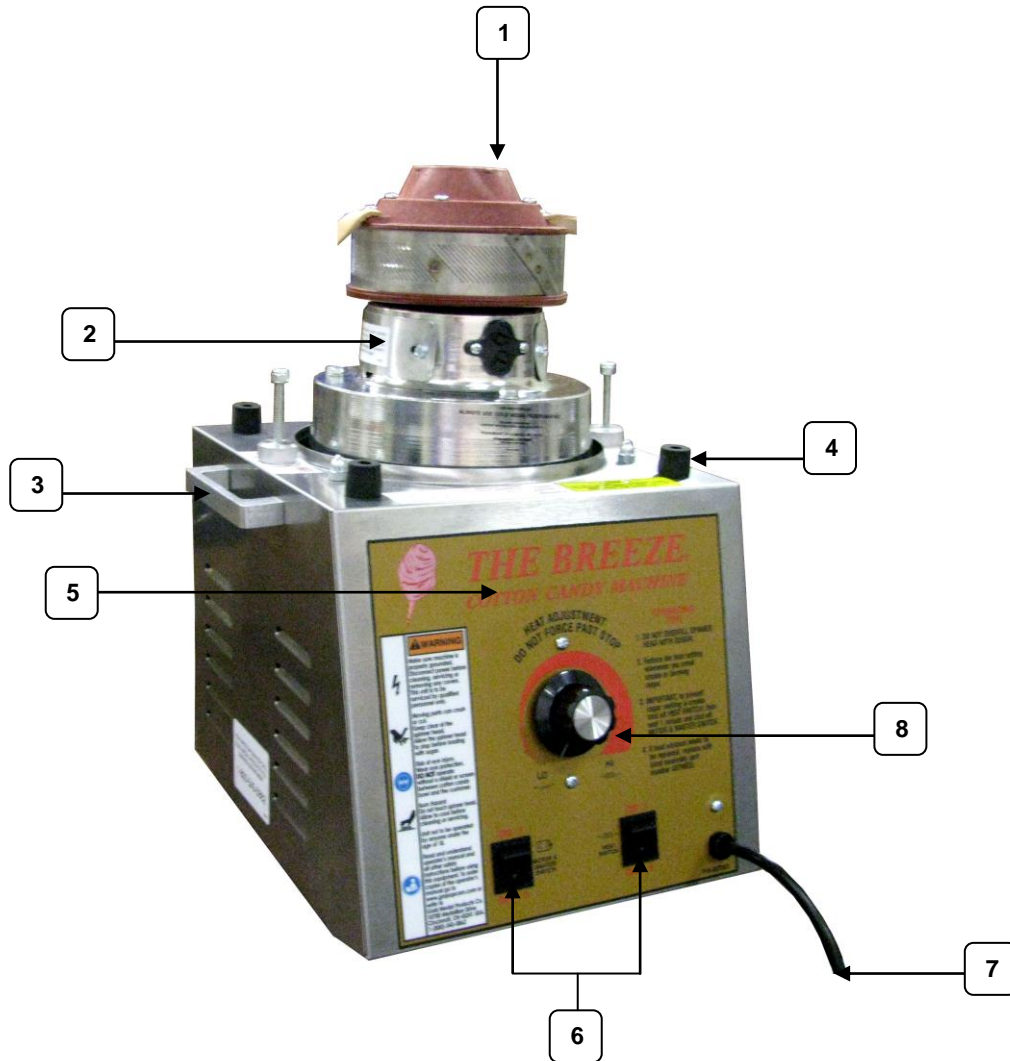

Item	Part No.	Description
1	42283T	Spinner Head, Complete (Domestic)
	42283TX	Spinner Head, Complete (Export)
2	42190	Bell Housing (Domestic)
	42191WX	Bell Housing (Export)
3	67069	Handle
4	47155	Rubber Feet ¾" High
5	48726	Nameplate (3030)
	48726EX	Nameplate (3030EX)
6	42798	Switch, Light Rocker Green (x2)
7	22038	Power Supply Cord (Domestic)
	42369	Power Supply Cord (Export)
8	42556	Knob, Heat Control

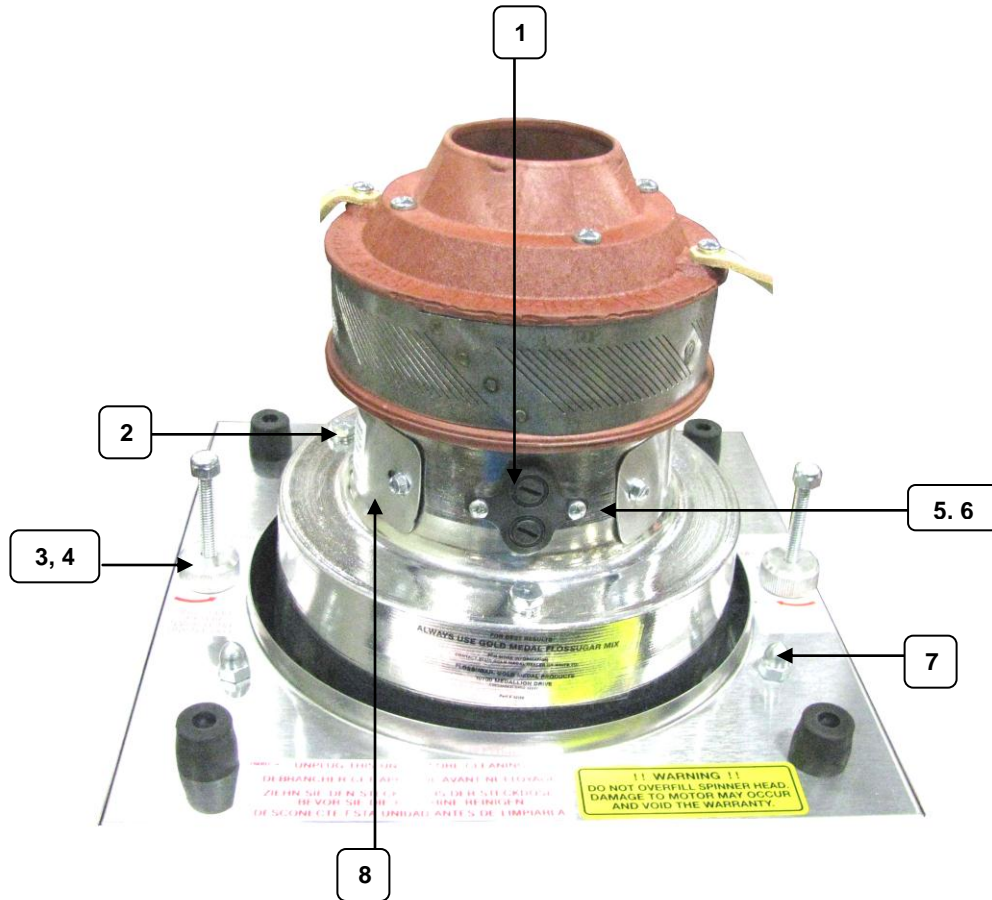

Item	Part No.	Description
1	42382W	Brush Holder Assembly
	42138	Brush Holder Cap
	42436	Brush Holder, 1/4" Wide Brushes (x2)
	42436W	Brush Holder, 3/8" Wide Brushes (x1)
2	49214	#8-32 x 3/8 Hex Head Screw (x4)
3	42150	Knob, Shipping Bracket
4	42183	Safety Bracket
5	42140	1/4" Wide Brushes
6	55007	3/8" Wide Brushes
7	49068	Acorn Nut 1/4-20
8	42381	Brush Inspection Cover (x2)

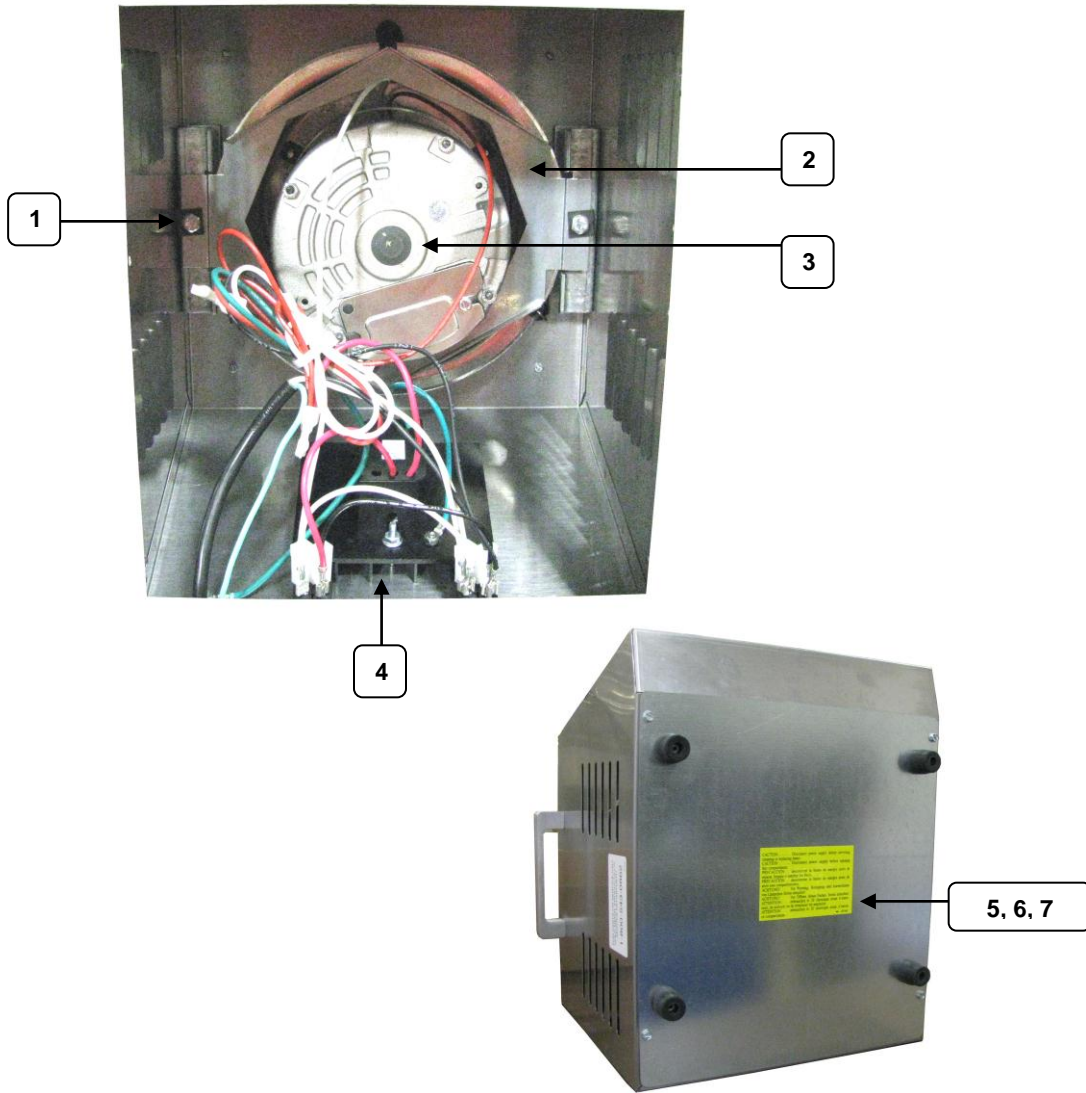

Item	Part No.	Description
1	42183	Safety Bracket
2	69839	Shipping Bracket Assembly
3	48649	Motor (Domestic)
	48649EX	Motor (Export)
4	42558	Electronic Heat Control, 120V (Domestic)
	55260EX	Electronic Heat Control, 240V (Export)
5	42448	Bottom Plate
6	89125	#8-32x3/4" Hex Head Screw (x4)
7	74133	Hex Nut 1/4-20" (x4)

3030SR & 3040SR – Handle Parts

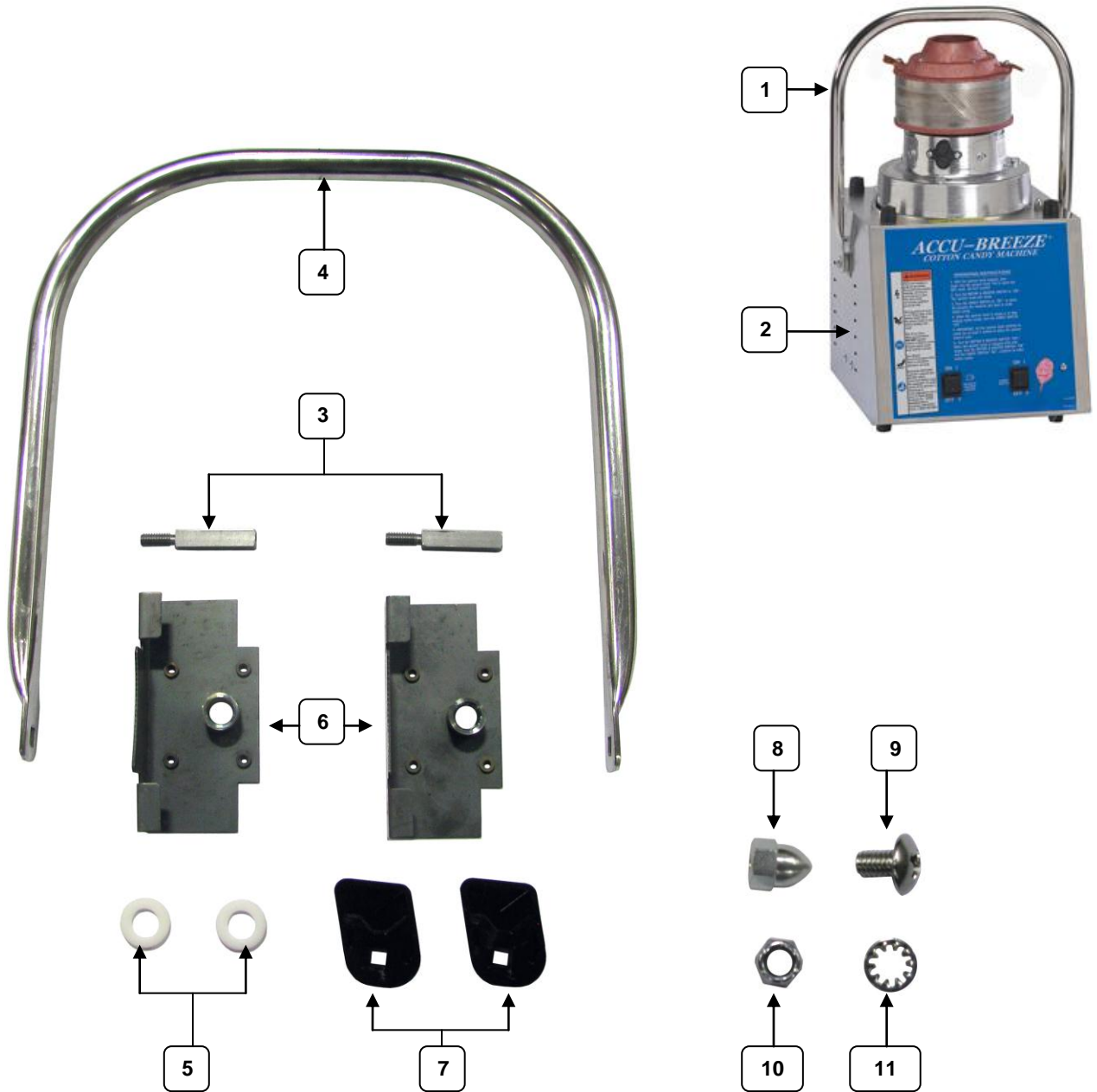

Item	Part No.	Description
1	42469	Lock N Go Handle, Complete Assy.
2	42472	Cabinet Weld, 3040SR
3	42462	Clamping Shaft (x2)
4	42464	Handle Bar
5	42468	Handle Spacer (x2)
6	42467	Clamping Bracket Assy. (x2)
7	42460	Clamping Cam (x2)
8	77610	Acorn Nut 5/18-18
9	12183	Screw 5/16-18 x 1/2 PH TR M/S
10	12001	Nylon Insert 5/16-18 Hex Nut
11	74137	Washer 5/16

3040 – Parts

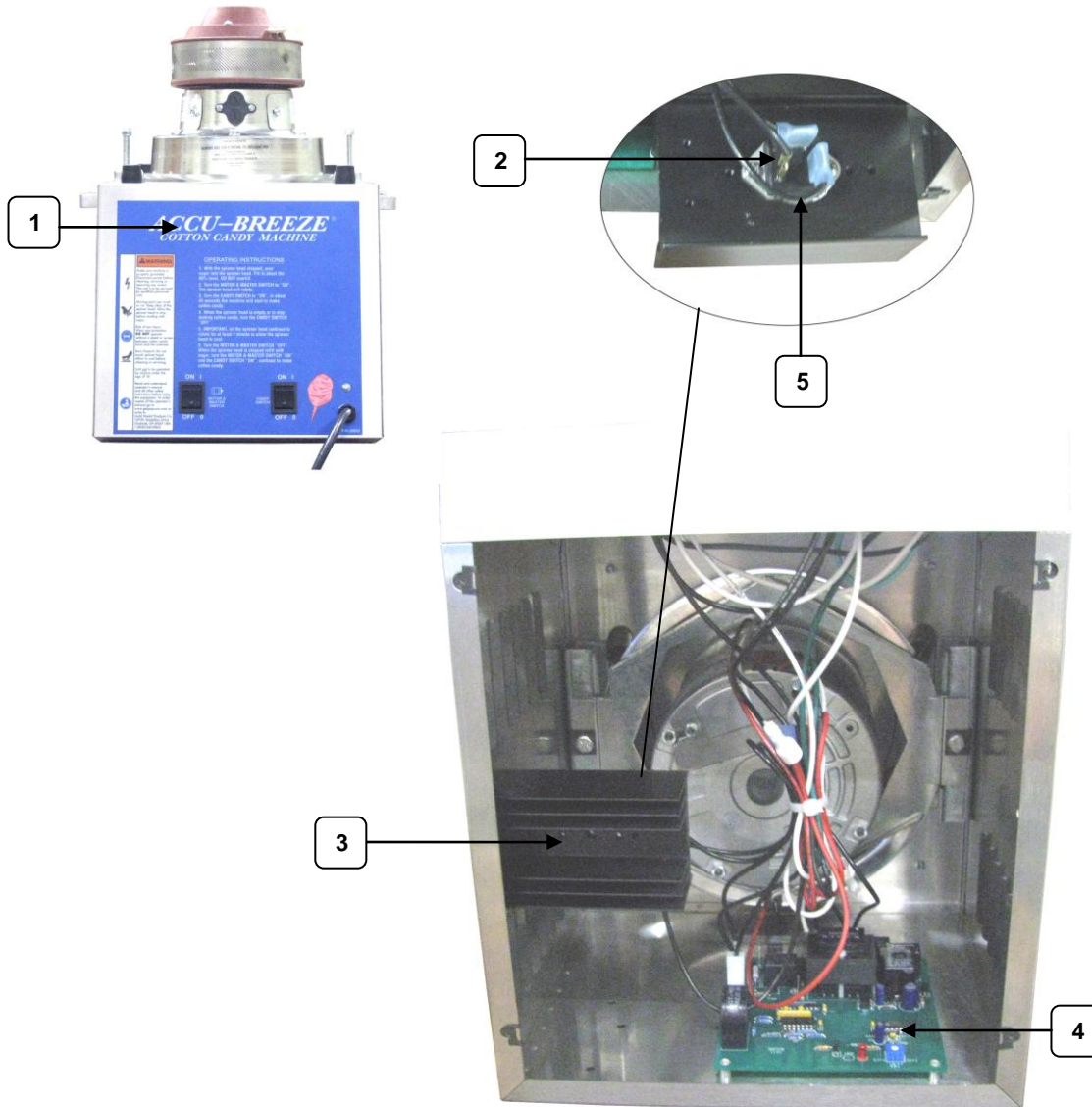

Item	Part No.	Description
1	55018	Name, Instruction Overlay
2	55155	Triac, 35A 600V
3	48673	Heat Sink
4	55447	Auto Watt Controller
5	87481	Thermal Compound

PARTS LIST-BREEZE FLOSS HEAD ASSEMBLY

Item No.	3030 Part No.	3030EX Part No.	Description	Qty./Machine
	42283T	42283TX	Spinner Head Complete	1
	42284T	42284T	Spinner Bottom	1
1	48767	48767	8-32 Locknut, Reversible	2
2	43166	43166	Spinner Cap, High Capacity	1
3	42281	42281	Lower Spinner Head	1
4	42045	42045	8-32 x 1/4" Hex Head Whiz Lock Screw	2
5	42162	42162	Terminal Guard, Phenolic	1
6	20054	20054	Bottom Washer, Phenolic	1
7	20010	20010	Leather Floater	2
8	42126	42126	Slip Ring 3/8" Wide	2
9	48041	48041	Acorn Nut, Nylon	1
10	20050	20050	Screw, #10-24 x 2 1/4"	4
11	89247	89247	Screw, #8-32 x 3/8 PH PAN	2
12	42413	42413	Set Screw, 1/4-20 x 2 3/4"	1
13	42127	42127	Slip Ring Stud	2
14	42301	42301	#10-32 Hex Nut, Brass	4
15	42215	42215	#10 External Tooth Washer	4
16	74125	74125	Set Screw, 1/4-20 x 3/8"	1
17	42305	42305	Terminal Assembly	2
18,19,20,21	48799	48799EX	Floss Band Assembly W/ Element Clamps, Counterweight & Nut	1
20	48798	48715	Floss Element Clamp/Bracket	3
21	48763	48763	Counterweight	1
22	42437	42437	Upper Spinner Head	1

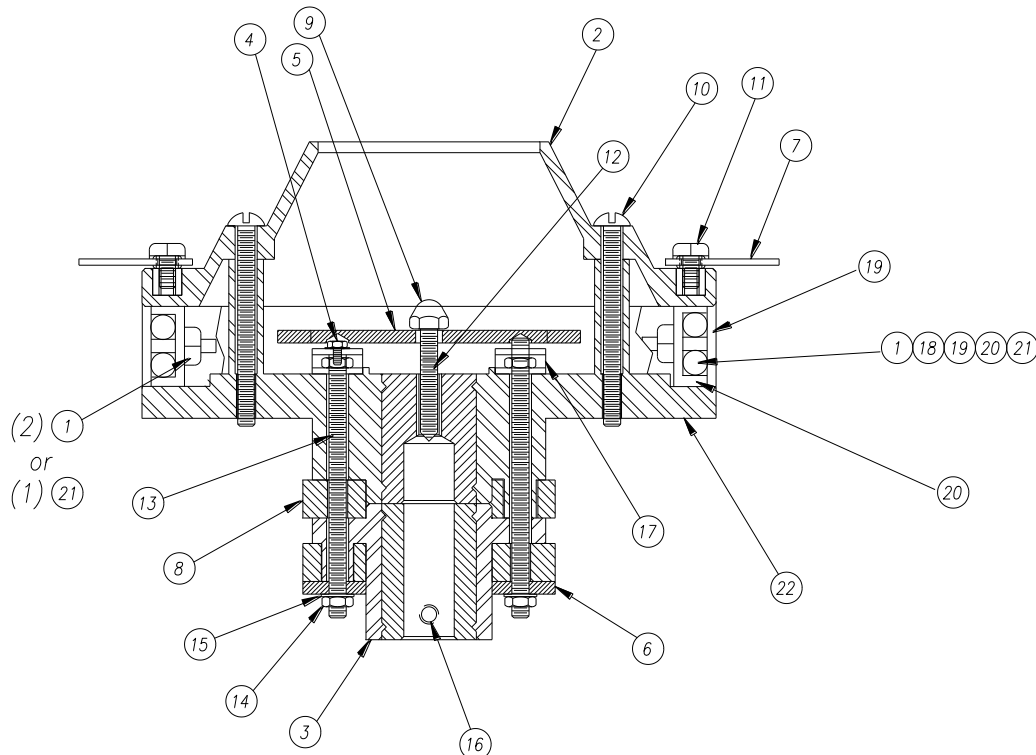

ELECTRICAL SCHEMATIC – DOMESTIC (3030, 3030SR)

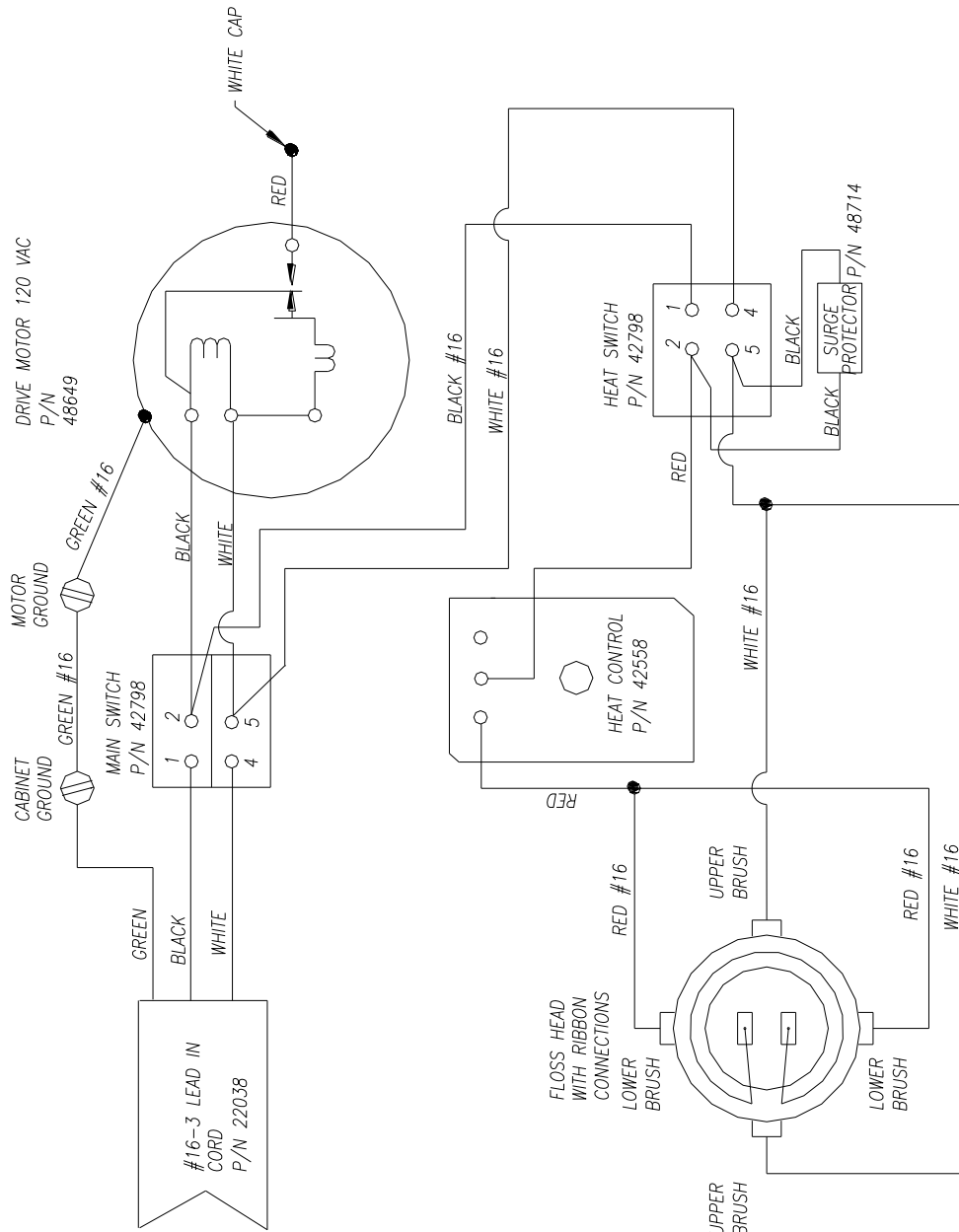

ELECTRICAL SCHEMATIC – EXPORT (3030EX)

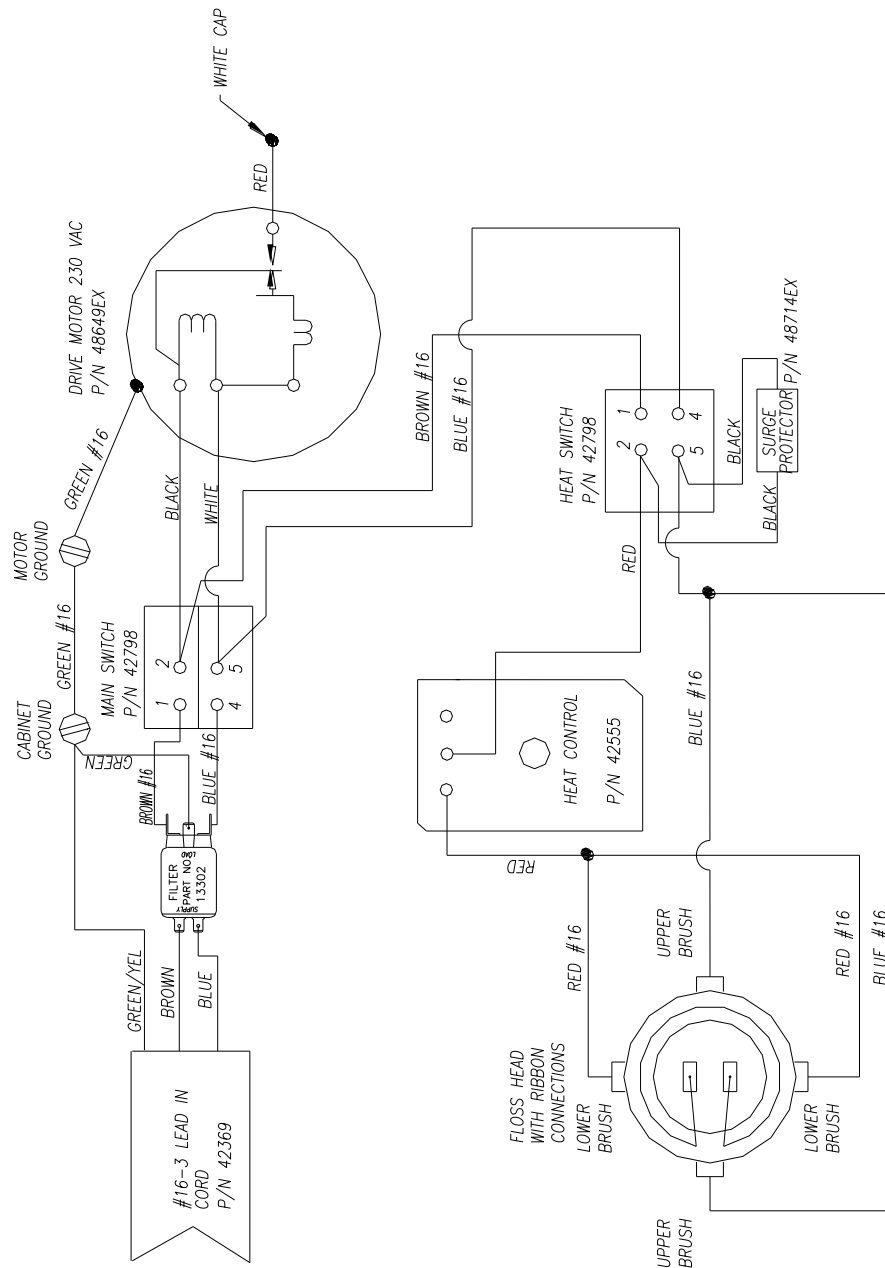

Electrical Schematic – 3040 & 3040SR

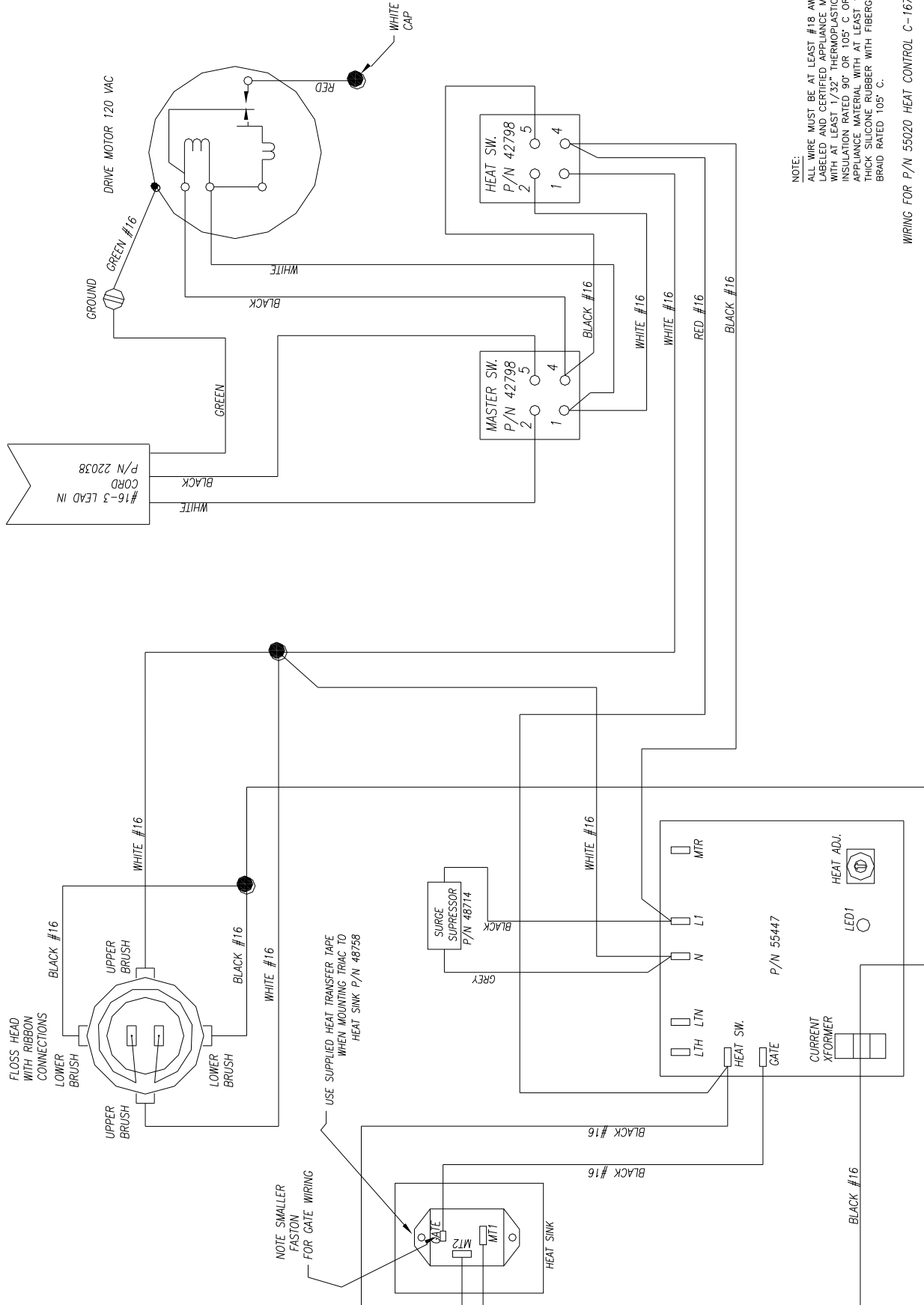

WARRANTY

WE WARRANT to the original purchaser the Gold Medal equipment sold by us to be free from defects in material or workmanship under normal use and service. Our obligation under this warranty shall be limited to the repair or replacement of any defective part for a period of six (6) months from the date of sale to the Original Purchaser with regard to labor and two (2) years with regard to parts and does not cover damage to the equipment caused by accident, alteration, improper use, voltage, abuse, or failure to follow instructions.

THIS WARRANTY IS IN LIEU OF ALL OTHER WARRANTIES EXPRESSED OR IMPLIED, AND OF ALL OTHER OBLIGATIONS OR LIABILITIES ON OUR PART, INCLUDING THE IMPLIED WARRANTY OF MERCHANTABILITY. THERE ARE NO WARRANTIES WHICH EXTEND BEYOND THE DESCRIPTION ON THE FACE HEREOF. We neither assume, nor authorize any other person to assume for us, any other obligation or liability in connection with the sale of said GOLD MEDAL equipment or any part thereof.

The term "Original Purchaser" as used in this warranty shall be deemed to mean that person, firm, association, or corporation who was billed by the GOLD MEDAL PRODUCTS COMPANY, or their authorized distributor for the equipment.

THIS WARRANTY HAS NO EFFECT AND IS VOID UNLESS THE ORIGINAL PURCHASER FIRST CALLS GOLD MEDAL PRODUCTS COMPANY AT 1-800-543-0862 TO DISCUSS WITH OUR SERVICE REPRESENTATIVE THE EQUIPMENT PROBLEM, AND, IF NECESSARY, FOR INSTRUCTIONS CONCERNING THE REPAIR OR REPLACEMENT OF PARTS.

NOTE: This equipment is manufactured and sold for commercial use only.



GOLD MEDAL PRODUCTS COMPANY

10700 Medallion Drive

Cincinnati, Ohio 45241-4807 USA

www.gmpopcorn.com

Phone: 1-800-543-0862

Fax: 1-800-542-1496