



# Instruction Manual

## Mighty-Mite

Model No. 2035BG, 2035EX, 2035DC



**GOLD MEDAL® PRODUCTS CO.**

10700 Medallion Drive, Cincinnati, Ohio 45241-4807 USA



## SAFETY PRECAUTIONS (continued)

	<b>DANGER</b>
	<p>Improper installation, adjustment, alteration, service, or maintenance can cause property damage, injury, or death. Any alterations to this equipment will void the warranty and may cause a dangerous condition. This appliance is not intended to be operated by means of an external timer or separate remote-control system. NEVER make alterations to this equipment. Read the Installation, Operating, and Maintenance Instructions thoroughly before installing, servicing, or operating this equipment.</p> <p style="text-align: right; font-size: small;">014_020416</p>

	<b>WARNING</b>
	<p>DO NOT store or use gasoline, or other flammable vapors and liquids, in the vicinity of this equipment.</p> <p style="text-align: right; font-size: small;">004_010914</p>

	<b>WARNING</b>
	<p>Instructions on what to do when a user smells gas can be obtained from the local gas supplier. These instructions must be posted in a prominent location where the unit is to be operated.</p> <p style="text-align: right; font-size: small;">005_010914</p>

	<b>WARNING</b>
	<p>To avoid burns, DO NOT touch the kettle or any heated surface. DO NOT place or leave objects in contact with heated surfaces.</p> <p style="text-align: right; font-size: small;">013_092414</p>

	<b>WARNING</b>
	<p>ALWAYS wear safety glasses when servicing this equipment.</p> <p style="text-align: right; font-size: small;">010_010914</p>

	<b>WARNING</b>
	<p>No user serviceable parts inside. Refer servicing to qualified service personnel.</p> <p style="text-align: right; font-size: small;">011_051514</p>

	<b>WARNING</b>
	<p>Read and understand operator's manual and all other safety instructions before using this equipment. To order copies of the operator's manual go to <a href="http://gmpopcorn.com">gmpopcorn.com</a> or write to Gold Medal Products Co., 10700 Medallion Drive, Cincinnati, OH 45241 USA 1-(800)-543-0862</p> <p style="text-align: right; font-size: small;">022_060215</p>



## SAFETY PRECAUTIONS (continued)

	<b>WARNING</b>
	<p>DO NOT allow direct contact of this equipment by the public when used in food service locations. Only personnel trained and experienced in the equipment operation may operate this equipment. Carefully read all instructions before operation.</p> <p style="text-align: right; font-size: small;">012_010914</p>

	<b>WARNING</b>
	<p>This machine is NOT to be operated by minors.</p> <p style="text-align: right; font-size: small;">007_010914</p>

This appliance is not intended for use by persons (including children) with reduced physical, sensory or mental capabilities, or lack of experience and knowledge, unless they have been given supervision or instruction concerning use of the appliance by a person responsible for their safety.

**Note:** Improvements are always being made to Gold Medal's equipment. This information may not be the latest available for your purposes. It is critical that you call Gold Medal's Technical Service Department at 1-800-543-0862 for any questions about your machine operations, replacement parts, or any service questions. (Gold Medal Products Co. does not assume any liability for injury due to careless handling and/or reckless operation of this equipment.) General images may be used in manual for reference only.

# INSTALLATION INSTRUCTIONS

## Inspection of Shipment

After unpacking, check thoroughly for any damage which may have occurred in transit. Claims should be filed immediately with the transportation company. The warranty does not cover damage that occurs in transit, or damage caused by abuse, or consequential damage due to the operation of this machine, since it is beyond our control (reference warranty in back of manual).

## Manual

Read and understand the operator's manual and all other safety instructions before using this equipment. To order copies of the operator's manual go to [gmpopcorn.com](http://gmpopcorn.com) or write to Gold Medal Products Co., 10700 Medallion Drive, Cincinnati, OH 45241 USA 1-(800)-543-0862.

## Model Description

**2035BG:** 16 oz. Mighty-Mite Popper, LP Gas, utilizes an electric kettle drive motor.

**2035EX:** Export, 16 oz. Mighty-Mite Popper, LP Gas, utilizes an electric kettle drive motor.

**2035DC:** 16 oz. Mighty-Mite Popper, LP Gas, utilizes a DC powered kettle drive motor (battery is not included with this unit).

## Items Included with this Unit

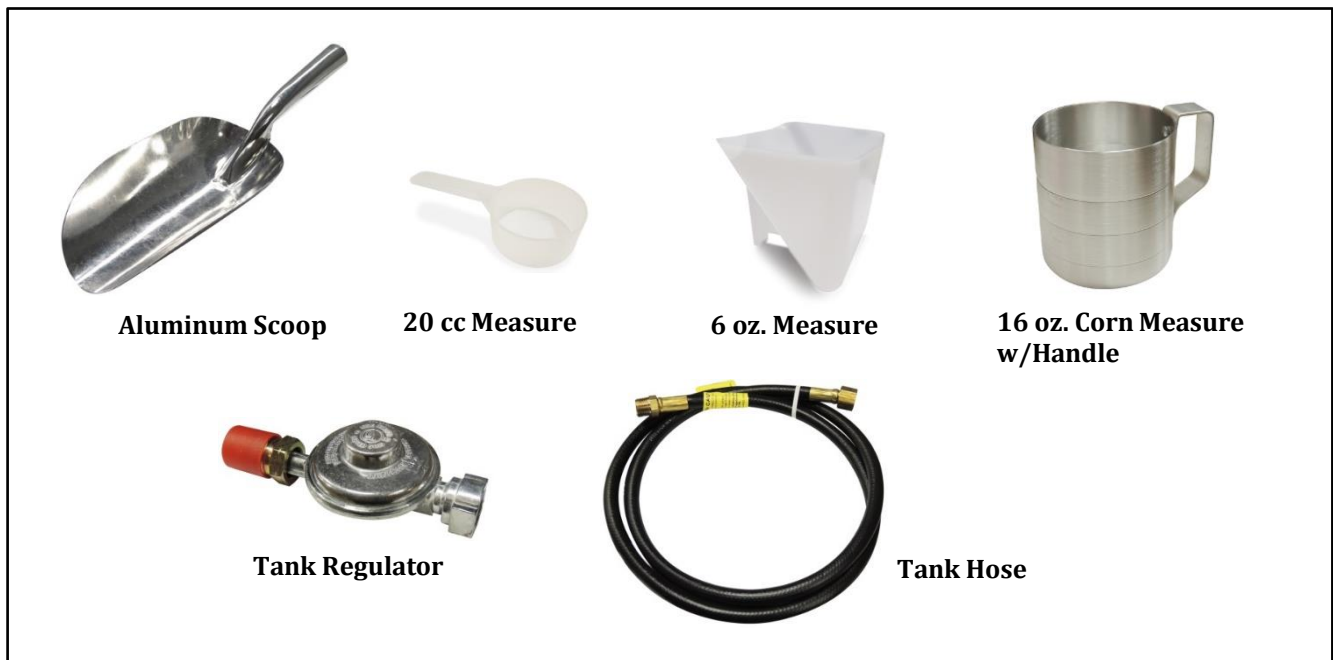



## Setup

This unit has been tested at the factory.

1. Remove all packaging and tape prior to operation.
2. This unit is for outdoor use only.
3. Place popper on a level, sufficiently stable base or counter that is strong enough to safely support it when in use. This unit is certified for use on combustible surfaces.
4. Observe the following clearances to ensure proper air supply and maintenance:
  - Minimum of 6 inches clearance on each side of unit.
  - Minimum of 30 inches clearance for the front, back, and top of unit.
5. Bolt the popper to the counter to secure it from tipping.
6. Attach the counterweight assembly per illustration below.
7. After setup, the unit should be cleaned prior to use (see Care and Cleaning section of this manual).

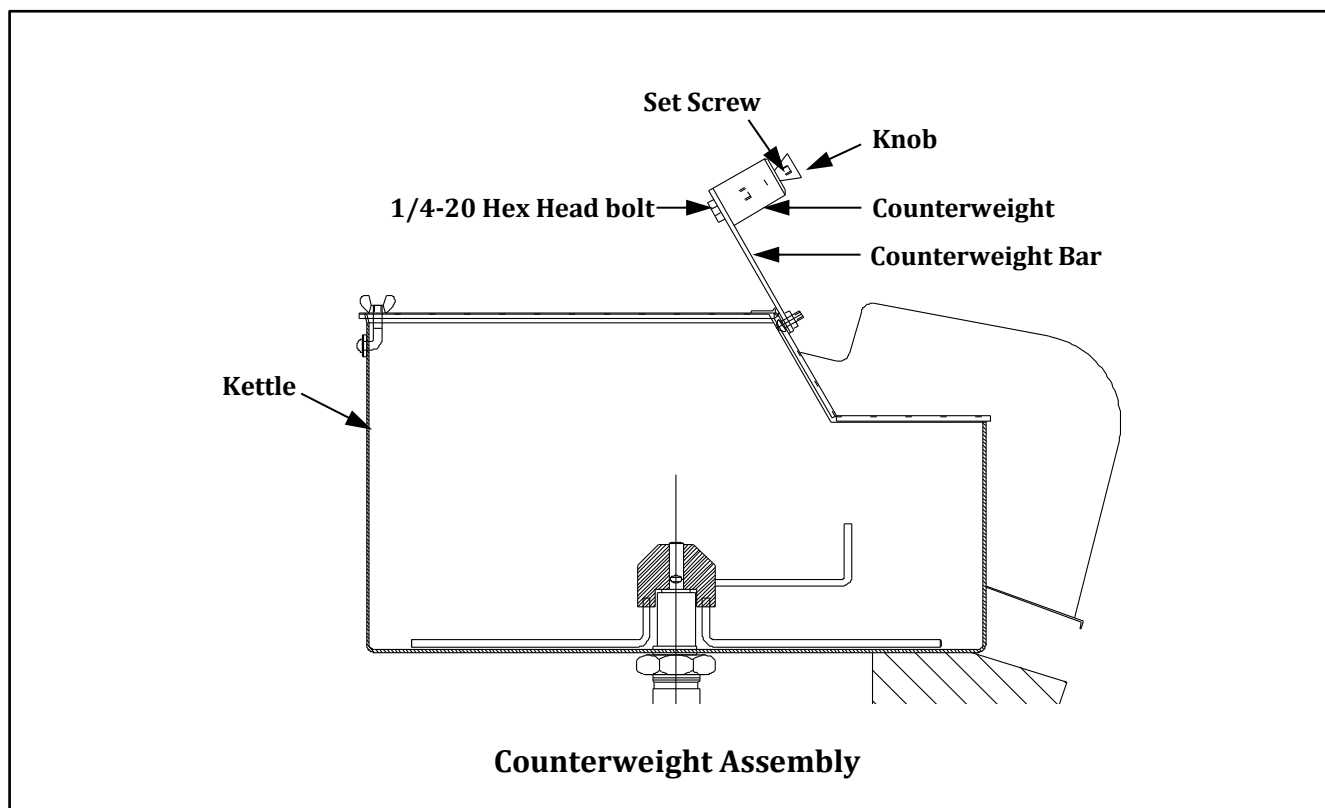



# Gas Installation Instructions

**DO NOT** connect the unit to a power source before gas connection is complete.

## Gas Requirements

The 2035BG, 2035EX, and 2035DC are designed for Propane only. Converting the unit to an alternate fuel source will void the warranty and may cause a dangerous condition.

**2035BG, 2035EX, and 2035DC:** Propane Gas, 12,600 BTU/HR

**NOTE:** The unit must be attached to a minimum of 40 pound LPG cylinder. For outdoor use only.



## Gas Installation

	 <b>DANGER</b>
	<p>Gas is safe when used properly, but can be very dangerous when used improperly. We suggest that installation be carefully made by qualified personnel only. Gas companies have competent service personnel to provide safe installation.</p> <p style="text-align: right; font-size: small;">001_010914</p>

When installing this gas unit in the United States, you must conform with local codes, or in the absence of local codes, with National Fuel Gas Code, ANSI Z223.1 (latest edition).

**NOTE:** Some local codes may require ventilation hoods or automatic fire systems. During any pressure testing of the gas supply piping system at pressure equal to or less than 1/2 psig (3.45 kPa), the appliance must be isolated from the gas supply piping system by closing its individual manual shutoff valve.



After installation, all gas connections must be checked for leaks with a soap solution (see Checking for Gas Leaks section of this manual).

	 <b>CAUTION</b>
	<p>Be sure to observe all clearances for this unit. Refer to the Setup Section of this manual to ensure proper air supply and adequate clearance for servicing and installation of this gas unit.</p> <p style="text-align: right; font-size: small;">033_042814</p>





## Important Fire Safety Notice

Consult your local fire protection agency for your area's requirements. Check local fire protection requirements regularly to ensure compliance with local codes and proper operation. Have a fire extinguisher near the unit. (Use only fire extinguishers approved for grease, oil, and electrical fires.)

	 <b>DANGER</b>
	<p>Hot oil is dangerous – severe burns can result when hot oil contacts the skin. Hot oil is flammable – keep open flames away from hot oil and its vapors. Keep a fire extinguisher near this unit. Instruct personnel on what to do if there is a grease fire. <b>DO NOT USE WATER ON A GREASE FIRE!</b> Use only fire extinguishers approved for grease, oil, and electric fire.</p> <p style="text-align: right; font-size: small;">002_102214</p>

## Checking For Gas Leaks

After making any gas connection, or after performing any work on the gas train, **ALWAYS** check ALL gas connections for leaks with a soap solution.

	 <b>DANGER</b>
	<p><b>DO NOT</b> use a match or flame to check for gas leaks – you may cause a fire or explosion! When gas connections are complete, have a qualified professional wire the unit to a power source which will carry the current specified on the unit's data plate.</p> <p style="text-align: right; font-size: small;">034_042814</p>

1. Apply **SOAP BUBBLES** to all connections and pressurize the gas line to check for leaks. Perform this test outdoors away from any flames or sparks.  
**DO NOT use a flame to check for gas leaks.**
2. It is recommended to check your flexible gas lines and gas fittings for wear and tear on a frequent basis. Stop using the appliance immediately if damage is found, and contact a qualified professional to inspect and correct any issue.
3. Securely route all gas lines away from flames and high temperature areas.
4. Contact Gold Medal Technical Support, or a qualified Gas Service Technician with any questions.

## Gas Pressure

We have determined that optimum popping occurs when the gas pressure is adequate. For propane gas, we recommend a manifold pressure setting of 10 inches of water column. The pressure is measured at the appliance when the main burner is ignited.

## Lighting and Shutdown Instructions

When gas installation is complete, the unit must be connected to a power source prior to lighting the unit (reference the Electrical Installation Instruction section). For pilot and burner lighting and shutdown instructions, refer to the Operating Instruction section of this manual.



BASO Gas Products LLC

 Installation Instructions H43  
 Issue Date August 20, 2008

## H43 Series BASO® Automatic Pilot Valve with Manual Shutoff

### Applications

The H43 Series BASO valve is a combination A valve and automatic pilot valve. A manual valve handle with On, Off, and Pilot positions allows operation of the valve without a thermostat. Applications include room heaters, wall furnaces, and commercial cooking.

**IMPORTANT:** Verify that the valve is installed only in applications where the specified maximum ambient (surface) temperature and maximum operating pressure do not exceed the limits in the *Technical Specifications* section.

### Installation

**IMPORTANT:** Only qualified personnel should install or service BASO® Gas Products. These instructions are a guide for such personnel. Carefully follow all instructions in this document and all instructions for the appliance.

To install the H43 valve:

1. Shut off power to the appliance (if applicable).
2. Shut off the gas at the main manual shutoff valve.
3. Ensure that the gas flows through the valve body in the direction indicated by the arrow on the valve body. If the valve is install with the gas flow in the opposite direction of the arrow, leakage can occur.

**IMPORTANT:** Make all gas installations in accordance with applicable local, national, and regional regulations.

**IMPORTANT:** Do not use a wrench on any surface other than the casting flats provided at the inlet and outlet ends of the valve body. The H43 may be damaged in the mounting process if a wrench is used on any other surface. Using a wrench incorrectly may void the warranty.

 **CAUTION: Risk of Electric Shock.**  
Disconnect power supply before making electrical connections to avoid electric shock.

**Note:** In applications that do not require electrical power, disregard the previous caution.

 **WARNING: Risk of Explosion or Fire.**  
Shut off the gas supply at the main manual shutoff valve before installing or servicing the H43. Failure to shut off the gas supply can result in the release of gas during installation or servicing, which can lead to an explosion or fire, and may result in severe personal injury or death.

4. Mount the valve to the pipework. Mount the H43 valve in any convenient position with the reset button and manual valve handle accessible. Use an approved pipe joint sealing compound on the male threads before assembly. Remove excess compound after mounting the valve to the pipework. Threads of the pipe and nipples must be smooth and free of tears and burrs. Steam clean all piping to remove foreign substances such as cutting oil or thread chips. A sediment trap needs to be installed in accordance with the National Fuel Gas Code NFPA 54 (Figure 1).





5. Attach the thermocouple securely to the pilot burner, and screw the terminal end to the BASO® power unit terminal on the valve. Make sure this connection is clean. Tighten the thermocouple lead nut finger tight, plus a maximum of 1/8 turn. Do not overtighten.
6. Attach the pilot gas line to the pilot burner fitting and the pilot gas connection of the H43 valve.



**WARNING: Risk of Explosion or Fire.**

Verify that there are no gas leaks by testing with appropriate equipment. Never use a match or lighter to test for the presence of gas. Failure to test properly can lead to an explosion or fire and may result in severe personal injury or death.

7. Check for leakage:
  - a. Shut off the gas at the main manual shutoff valve and open the pressure connection between the manual shutoff valve and the H43 valve.
  - b. Connect air tubing with a maximum pressure of 1-1/2 times the valve's maximum operating pressure (as indicated on the valve) to the opened pressure connection.
  - c. Paint all valve body connections with a rich soap and water solution.
 

If bubbles occur, this is an indication of a leak. To stop a leak, tighten joints and connections. Replace the part if the leak cannot be stopped.

If bubbles do not occur, remove the air tubing and close the pressure connection.
8. Perform the *Checkout* section before leaving the installation.

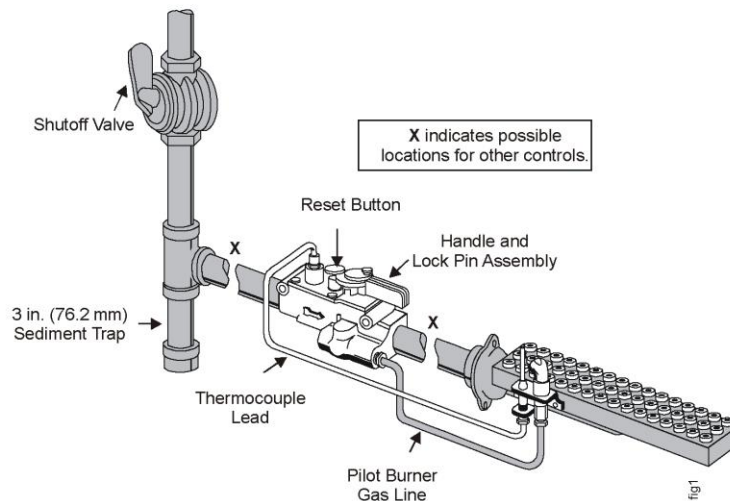

**Figure 1: Typical H43 Installation**



## Setup and Adjustments

### Checkout

**⚠ WARNING: Risk of Explosion or Fire.**  
 Follow this or an equivalent checkout procedure after installation. Before leaving the installation, verify that the gas valve functions properly and that the system has no gas leaks. Gas leaks can lead to an explosion or fire, and may result in severe personal injury or death.

Make sure all components are functioning properly by performing the following test.

1. Test all joints and connections for leaks with a soap solution.
2. For models H43A\_ and H43B\_, close the shutoff valve and wait at least 5 minutes for unburned gas to escape from the appliance. Reopen the shutoff valve.

For Model H43G\_, close the valve. Pilot and the main burner gas are shut off when the valve is in the Off position. To turn the valve off, push in the handle and turn it to the Off position while holding the handle in (see Figure 2 for handle positions). Wait at least 5 minutes for unburned gas to escape from the appliance.

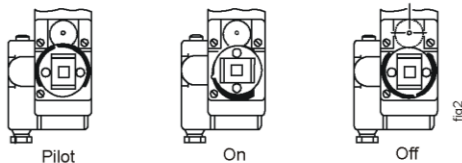

**Figure 2: Handle Positions**

3. Turn the handle to the pilot position (see handle on the valve).
4. Push the reset button down and light the pilot burner. Continue to hold down the reset button for 30 to 45 seconds or until the pilot remains burning when the reset button or handle is released.
5. Turn the handle to the On position. The main burner should be ignited by the pilot burner.

6. Throttle between On and Pilot position only (if the H43 manual valve is used to throttle the main burner).

**Note:** In the Off position, the valve shuts off both the pilot and the main burner gas. For Models H43A\_\_ or H43B\_, turn off by pulling the lock button and the handle to Off. H43G\_ models do not have a lock button.

7. Adjust the pilot flame (on valves that provide pilot adjustment) by removing the slotted pipe plug and turning the inner screw to the right to decrease, or to the left to increase, the pilot burner gas. Replace the slotted pipe plug and tighten it securely to avoid any gas leakage.
8. Check the millivoltage (mV) output of the thermocouple and the milliampere (mA) dropout range of the BASO power unit to be sure the meet the values in. Step-by-step procedures for these checks are included with the *Y99AB-4 BASO Test Kit Application Note*.
9. Observe at least three complete operating cycles to make sure that all components are functioning properly.
10. Reset the thermostat to the desired setting before leaving the installation.

**Table 1: Thermocouple Output**

Thermocouple		mV Range	
Lead Type	Turn Down	Normal	Not Less Than
K15	4 mV	20-28	15
K16	4 mV	25-35	17
K19	4 mV	25-35	17

**Table 2: Power Unit Dropout Range**

Series Number	mA Range	
	Low	High
H43AA, H43BA, H43GA	100	300
H43AB, H43BB	50	165



### Pilot Servicing

If pilot flame problems occur, check the following:

- If the pilot flame burns yellow, it may be due to dirt or lint covering the lower portion of the pilot burner. Remove this using a soft brush or a vacuum.
- A flame approximately 1/2 in. (12.7 mm) high must surround the thermocouple tip (Figure 3).
- Because this is an electrical connection, the thermocouple lead connection to the BASO power unit must be clean and free of grease.

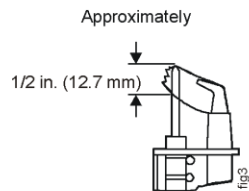

**Figure 3: Flame Position**

### Repairs and Replacement



**WARNING: Risk of Explosion or Fire.**

Shut off the gas supply at the main manual shutoff valve before installing or servicing the H43. Failure to shut off the gas supply can result in the release of gas during installation or servicing, which can lead to an explosion or fire, and may result in severe personal injury or death.

Field repairs must not be made to the H43 valve. If the thermocouple meets the output listed in Table 1 and the valve does not function, replace the entire valve. Any attempt to repair this assembly voids the manufacturer's warranty. For a replacement valve, contact the original equipment manufacturer or the nearest BASO Gas Products distributor.



### Technical Specifications

<b>Product</b>	H43 Series BASO Automatic Pilot Valve with Manual Shutoff
<b>Maximum Operating Pressure</b>	0.5 psi (35 mbar)
<b>Valve Body</b>	Aluminum
<b>Permissible Ambient (Surface) Temperature</b>	32 to 175°F (0 to 79°C) H43_A models 32 to 250°F (0 to 121°C) H43_B models
<b>Recommended Thermocouple Lead Lengths</b>	K15: 12 to 48 in. (305 to 1,220 mm) K16: 12 to 72 in. (305 to 1,830 mm) K19: 18 to 72 in. (457 to 1,830 mm)
<b>Inlet and Outlet Body Connections</b>	3/8 or 1/2-in. NPT
<b>Types of Gas</b>	Natural, Liquefied Petroleum (LP), or LP gas-air mixtures
<b>Packaging</b>	Bulk pack supplied to original equipment manufacturer (individual pack optional)
<b>Bulk Pack Quantity</b>	60
<b>Bulk Pack Weight</b>	51 lb (23 kg)
<b>Agency Listing</b>	CSA (AGA/CGA) Certificate Number 229521-1656111 UL File Number MH2926 (H43AA and BA models only)
<b>Specification Standards</b>	ANSI Z21.78, CSA 6.20 UL Standard 372

*Performance specifications are nominal and conform to acceptable industry standards. All agency certification of BASO products is performed under dry and controlled indoor environmental conditions. Use of BASO products beyond these conditions is not recommended and may void the warranty. Product must be protected if exposed to water (dripping, spraying, rain, etc.) or other harsh environments. The original equipment manufacturer or end user is responsible for the correct application of BASO products. Consult BASO Gas Products LLC for questionable applications. BASO Gas Products LLC shall not be liable for damages or product malfunctions resulting from misapplication or misuse of its products.*

Refer to the *H43 Series BASO Automatic Pilot Valve with Manual Shutoff Product Bulletin (BASO-PB-H43)* for necessary information on operating and performance specifications for this product.



BASO Gas Products LLC

1007 South 12th Street  
PO Box 170  
Watertown, WI 53094  
1-877-227-6427 (1-877-BASOGAS)

[www.baso.com](http://www.baso.com)  
Published in U.S.A.

H43 Series BASO Automatic Pilot Valve with Manual Shutoff Installation Instructions **5**



# Electrical Installation Instructions

**DO NOT** connect this unit to a power source until gas installation is complete (reference the Gas Installation Instructions section of this manual).

## Electrical Requirements

This unit must be wired in accordance with local electric and building code requirements by a qualified technician. Model 2035BG and 2035EX are supplied with a hot, neutral, and ground lead as shown in image below. Model 2035DC is supplied with a black (negative) lead and a red (positive) lead as shown in the image below.

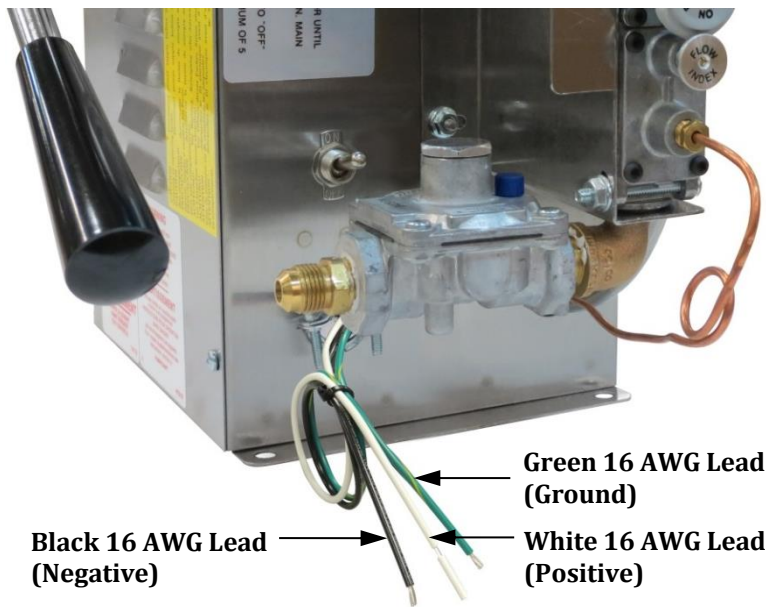

**Model 2035BG (wire nuts and cord/plug not included)**

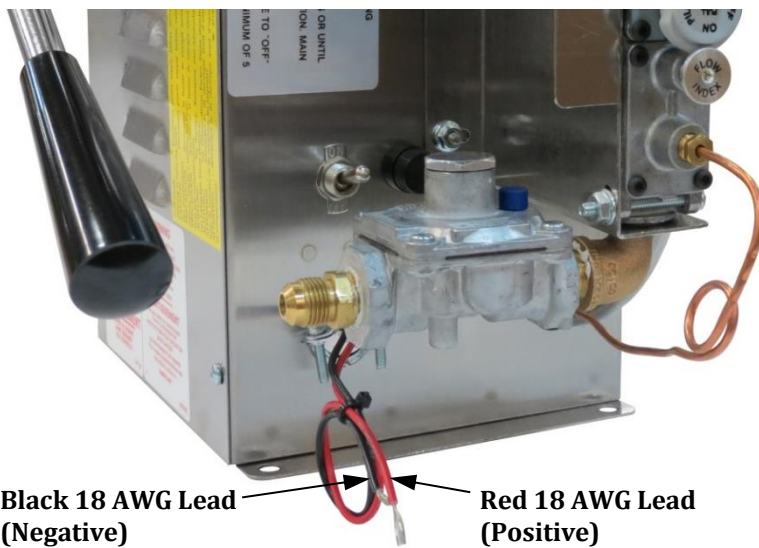



**Model 2035DC (wire nuts and battery not included)**

The following power supply must be provided:

**2035BG:** 115 Volts, 115 Watts, 60 Hertz

**2035EX:** 230 Volts, 115 Watts, 50 Hertz

**2035DC:** 12 Volt DC (Battery not included with this unit; customer must supply 12 volt battery for proper machine operation.) Follow all safety precautions provided by the battery manufacturer. Motor is rated at 12VDC, 0.5 AMPs.

	 <b>DANGER</b>
	<p>Machine must be properly grounded to prevent electrical shock to personnel. Failure to do so could result in serious injury, or death. DO NOT immerse any part of this equipment in water. DO NOT use excessive water when cleaning. Keep cord and plug off the ground and away from moisture. Always unplug the equipment before cleaning or servicing. Make sure all machine switches are in the OFF position before plugging the equipment into the receptacle.</p> <p>008_051514</p>

A certified electrician must furnish sufficient power for proper machine operation. We recommend this equipment be on a dedicated and protected circuit. Failure to wire properly will void the warranty and may result in damage to the machine. It is Gold Medal Products Co.'s recommendation that this machine be plugged directly into a wall outlet. The use of extension cords is not recommended due to safety concerns, and may cause sacrificed and/or reduced performance. Make sure cord is located to prevent a trip hazard or unit upset.

## Before You Connect Power to the Machine

### Model 2035BG, 2035EX (Electric)

1. Make sure all machine switches and gas valves are OFF, before plugging the unit into the receptacle.
2. Make sure the wall outlet can accept the grounded plugs (where applicable) on the power supply cord.
3. The wall outlet must have the proper polarity. If in doubt, have a competent electrician inspect the outlet and correct if necessary.
4. **DO NOT** use a grounded to un-grounded receptacle adapter (where applicable).
5. Install the unit in a level position.

### Model 2035DC (Battery)

1. Make sure all machine switches and gas valves are OFF, before connecting the unit to the battery.
2. Cables must be attached to the proper polarity. Red is "+" positive; black is "-" negative.
3. Install the unit in a level position.



# OPERATING INSTRUCTIONS

## Controls and Their Functions

### GAS SAFETY VALVE

The Gas Safety Valve has three settings used to control gas flow; PILOT, ON, and OFF positions. (Reference image below and the Lighting and Shutdown Instructions in the Operating Instruction section of this manual.)

**PILOT** position - When the Gas Safety Valve handle is in the **PILOT** position, the Safety Valve Button may be pressed to provide gas for lighting the pilot.

**ON** position - Once the pilot is lit, turn the Gas Safety Valve handle to the **ON** position to ignite the main burner for use.

**OFF** position - The Lock Button on the Gas Safety Valve handle must be pulled out to rotate the valve into the **OFF** position.

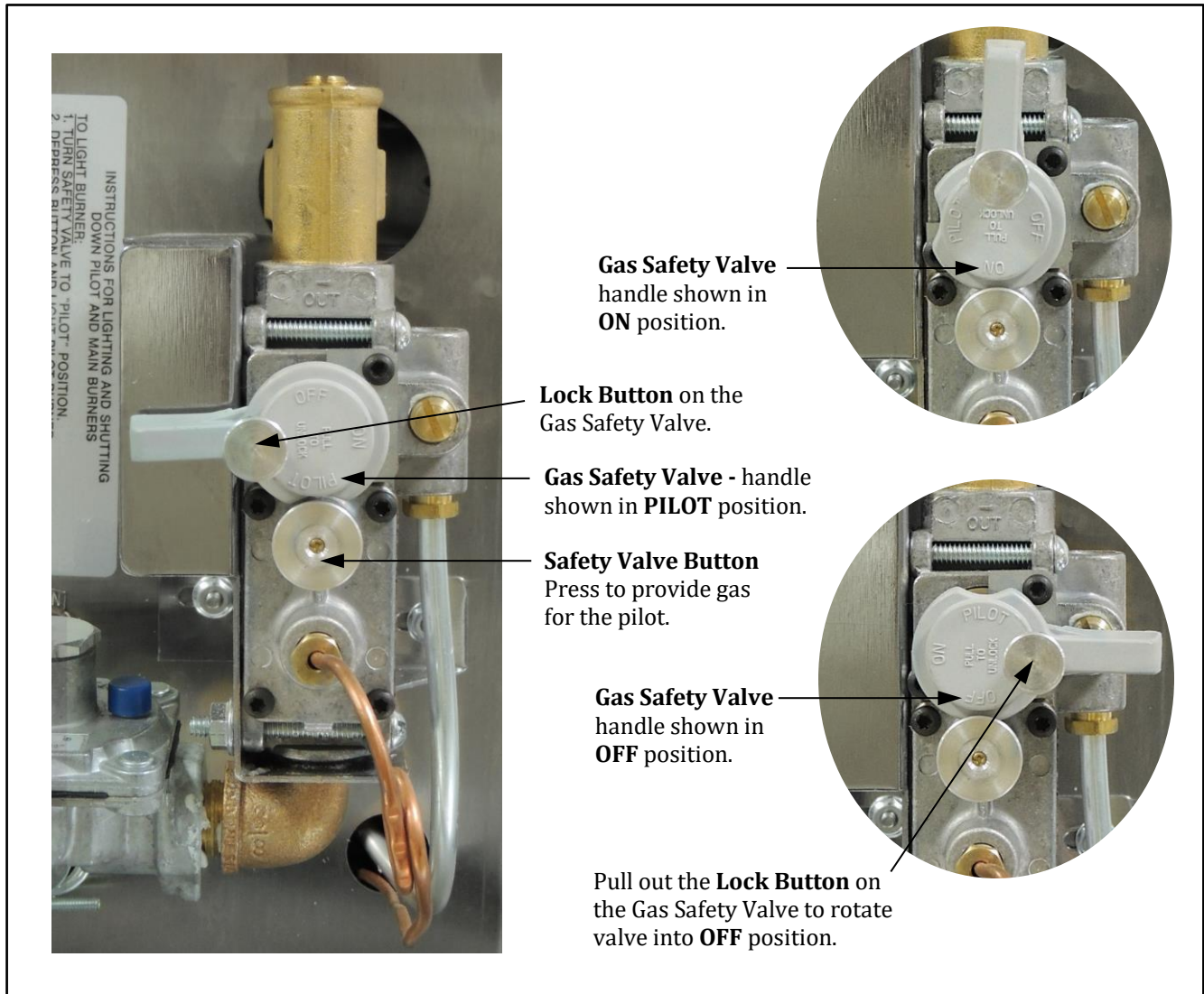



### KETTLE MOTOR SWITCH

Two position, ON/OFF toggle switch which provides power to the kettle agitator drive motor.  
**DO NOT** pop corn if the agitator is **NOT** rotating.

### 2.5 AMP FUSE (Model 2035DC Only)

The 2.5 AMP Fuse protects the motor from overload condition.

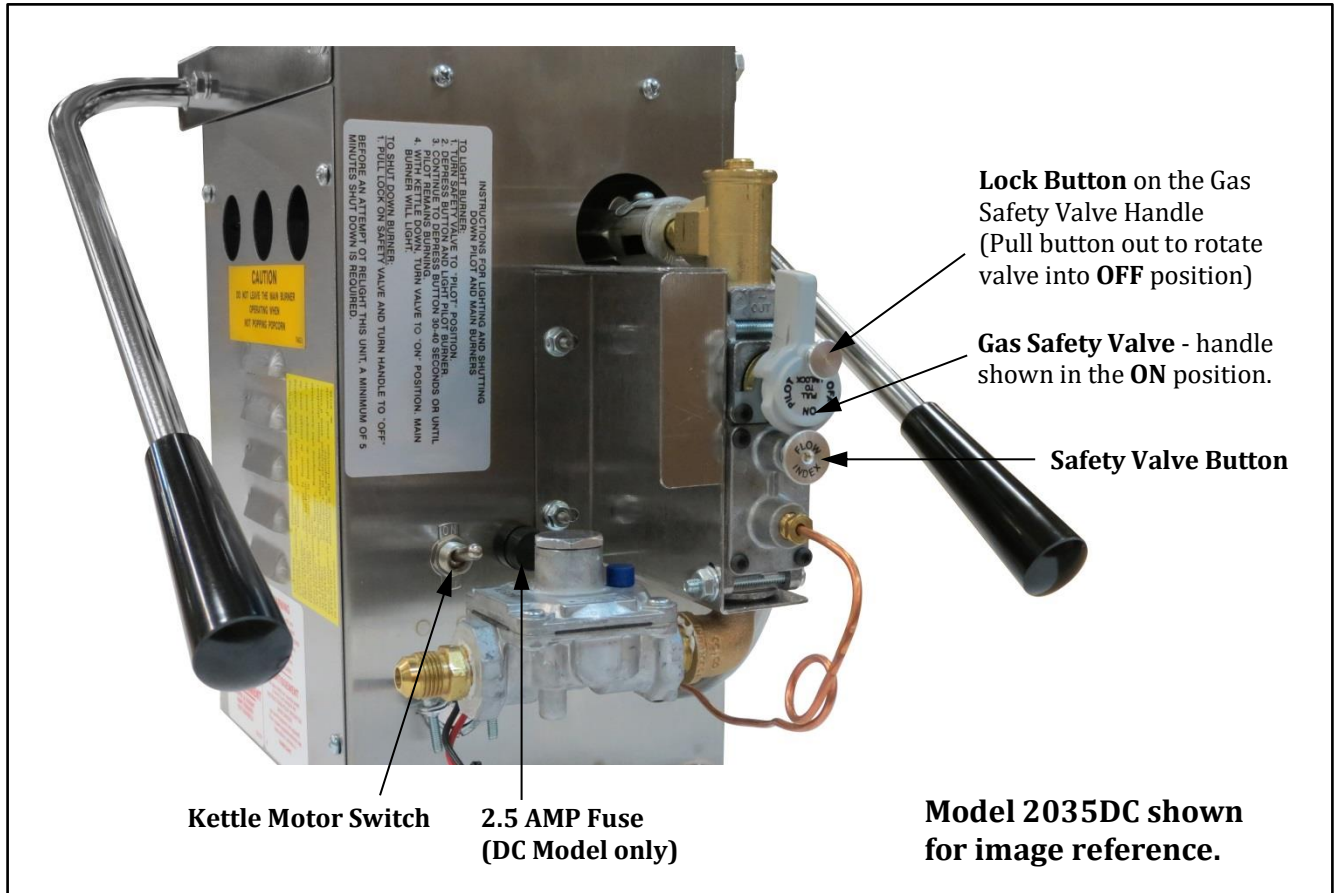





# Lighting and Shutdown Instructions

## Steps to Light the Pilot and Burner:

1. Turn the Gas Safety Valve to the PILOT position.
2. Depress the Safety Valve Button next to the Gas Safety Valve Handle. Hold this button down for 30-45 seconds.
3. Light the pilot burner with a household match. Continue to hold the Safety Valve Button for approximately 20 seconds. Release the Safety Valve Button and the pilot burner will remain light.
4. Turn the Gas Safety Valve Handle to the ON position. The main burner will ignite.

## Steps to Shut Down the Pilot and Burner:

1. To extinguish both the pilot and the main burner flames, pull the Lock Button on the Gas Safety Valve Handle, and turn the Gas Safety Valve Handle to the OFF position.
2. Should the burner become extinguished because of the high-limit tripping, shut off the gas supply until the unit cools down, then re-light.

	<b>⚠ CAUTION</b>
	If pilot is turned off, a five minute shutdown period is required before attempting to re-light.

035\_042814

## Air Adjustment on Burner

After the main burner is lit, according to the directions, make any needed air adjustments in order to get the best flame. Turn the Air Adjustment Cap (see image below) to supply more or less air. A blue flame provides optimum heat.

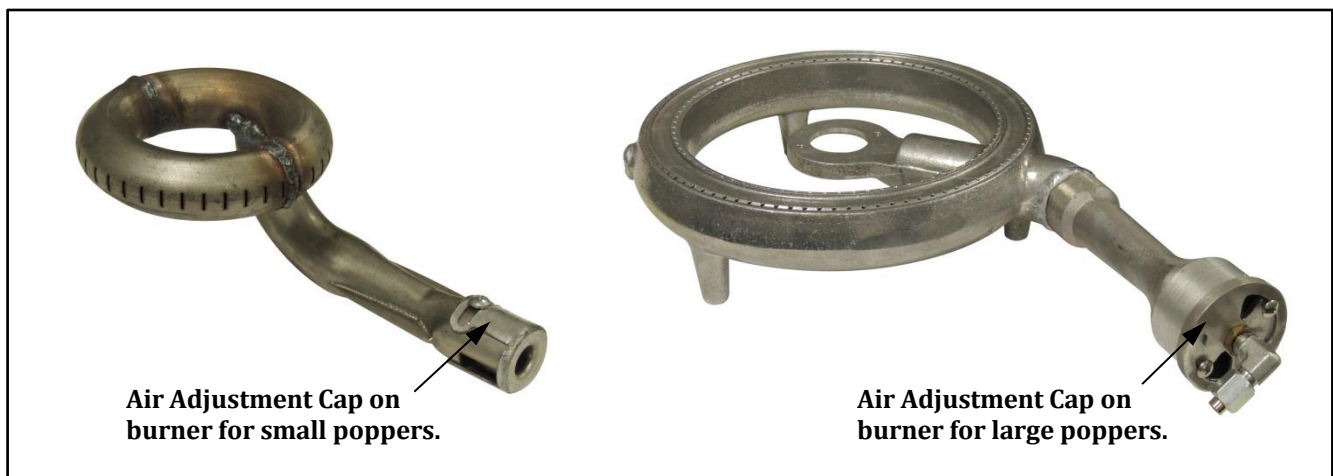





## If the Flame Goes Out

If the flame goes out, a **five minute shutdown period is required before attempting to re-light.**

1. Check to see if you are out of gas.
2. Check to see if the thermocouple is in the proper position.

	 <b>WARNING</b>
	<p><b>AT NO TIME</b> during a power failure should an attempt be made to operate this unit.</p> <p>If power failure occurs during operation, the gas supply is to be turned OFF until power failure has subsided. Then, and only then, should a relight attempt be made per the Lighting and Shutdown Instructions.</p> <p>036_042814</p>



# Popping Corn Instructions

This section describes popping instructions for Standard (Salted) Popcorn using a gas popper.

## Amount of Popcorn and Oil

The popper is equipped with a corn, salt, and oil measure. We recommend flavored and colored coconut oil. Popcorn popped in coconut oil stays fresh longer and does not leave black deposits in the kettle like other oils. Use only top quality, fresh popcorn from reputable suppliers.

Kettle Size	Popcorn Charge	Oil Charge	Flavacol (Salt)
16 oz.	16 oz. (473 ml)	5 oz. (148 ml)	1.5 Tblsp. (20cc)

For best results use Mega-Pop® 16 oz. premeasured pouches (Item# 2846).

## Popping Popcorn

1. Turn Main Burner ON (follow the burner lighting instructions found in the Operating Instructions section of this manual).
2. Turn Kettle Motor Switch ON.
3. To determine when kettle is ready to pop corn, test pop three kernels of corn and one ounce (30 ml) of popping oil. When kernels pop, kettle is ready.
4. Lift kettle lid and load Mega-Pop® premeasured popcorn and oil pouch, or pour in popcorn and Flavacol (see chart above), then add oil in premeasured amount; close lid.
5. When the corn has finished popping, gently dump the popcorn.
6. On final kettle of corn, turn the Main Burner OFF just as the lids are forced open by the popping corn. This procedure helps eliminate smoke/odor from any oil residue that remains after popping has stopped.
7. When finished popping, make sure the MAIN BURNER and KETTLE MOTOR switch are turned OFF.

**NEVER LEAVE THE MAIN BURNER IN OPERATION WHEN NOT POPPING CORN!**

## Care and Cleaning

	<b>⚠ DANGER</b>
	Machine must be properly grounded to prevent electrical shock to personnel. <b>DO NOT immerse in water.</b> DO NOT clean appliance with a water jet. Always unplug the equipment before cleaning or servicing. <span style="float: right;">025_111616</span>

	<b>⚠ WARNING</b>
	To avoid serious burns, DO NOT touch the kettle while it is hot! <span style="float: right;">028_082715</span>

Good sanitation practice demands that all food preparation equipment be cleaned regularly (only use non-toxic, food grade cleaners). A clean looking, well-kept machine is one of the best ways of advertising your product.

**Note:** It is extremely important to follow all of the cleaning procedures, otherwise parts damage and equipment failure will result. The warranty does not cover parts that are damaged due to improper cleaning.

### Daily Kettle Cleaning Instructions

**CAUTION:** A hot kettle will cause burns if you touch it with your hand. Allow kettle to cool at least 1 hour before attempting to clean. **DO NOT** use ice or water to cool down a hot kettle! Severe kettle damage will result!

1. When cool, wipe **outside** of kettle with a clean, soft cloth. **DO NOT** use oven cleaners or abrasive materials as they will damage the kettle.
2. Every night, mix Gold Medal's Heat'n Kleen solution (Item No. 2095), 2 tablespoons per gallon of water. It is not necessary to use the entire gallon at once; only use enough to fill the kettle 1/2 inch deep.
3. Turn kettle heat ON. When water starts to boil, turn kettle heat OFF.
4. Allow to cool at least 1 hour, then dump solution into a bucket and wipe inside of kettle with a clean cloth. Make sure all solution goes into the bucket; do not spill any in the interior of machine.

For an extra dirty kettle, the process may be repeated; or, after turning kettle heat OFF, allow solution to sit in kettle overnight. The next morning, dump solution into a bucket and wipe inside of kettle with a clean cloth.



---

## Daily Unit Cleaning Instructions

1. Follow the burner shutdown instructions, turn machine OFF, and allow unit to cool. Once cool, disconnect unit from its power source before attempting to clean.
2. Clean all pans/accessories in order to sanitize them before each use.
3. Take a clean, SLIGHTLY damp cloth and wipe excess grease from unit.
4. Wipe stainless steel parts with a clean cloth and cleaner designed for stainless steel, such as Gold Medal Watchdog Stainless Cleaner (Item No. 2088).

**DO NOT** use oven cleaners or abrasive materials as they will damage parts of machine.







## Troubleshooting



Issue	Possible Cause	Solution
<b>Gas Issues</b>		A. For gas issues refer to the initial Gas Setup Instructions.
<b>Long Popping Cycles</b> (Longer than 4 minutes)	A. Inferior Corn	A. Inferior quality corn would result in longer popping cycles. Use only top quality hybrid popcorn from reputable suppliers. Even then, if you let your corn pick up moisture or dry out, your popping cycles will be slow.
<b>Kettle Agitator not Rotating</b>	A. Kettle Motor Switch  B. Fuse (if equipped)	A. Check to make sure the unit has power and the Kettle Motor Switch is ON. If the switch is ON, and the agitator is not rotating, <b>DO NOT</b> pop corn. The switch may be faulty, contact qualified service personnel for inspection/repair.  B. Check the condition of the fuse. Replace if required, if fuse trips again; contact qualified service personnel for inspection/repair before going any further.







# MAINTENANCE INSTRUCTIONS

	 <b>DANGER</b>
	<p>Machine must be properly grounded to prevent electrical shock to personnel. Failure to do so could result in serious injury, or death.  <b>DO NOT</b> immerse any part of this equipment in water.  <b>DO NOT</b> use excessive water when cleaning.            Keep cord and plug off the ground and away from moisture.            Always unplug the equipment before cleaning or servicing.            Make sure all machine switches are in the OFF position before plugging the equipment into the receptacle.</p> <p style="text-align: right; font-size: small;">008_051514</p>

	 <b>DANGER</b>
	<p>Improper installation, adjustment, alteration, service, or maintenance can cause property damage, injury, or death. Any alterations to this equipment will void the warranty and may cause a dangerous condition. This appliance is not intended to be operated by means of an external timer or separate remote-control system. <b>NEVER</b> make alterations to this equipment. Read the Installation, Operating, and Maintenance Instructions thoroughly before installing, servicing, or operating this equipment.</p> <p style="text-align: right; font-size: small;">014_020416</p>

	 <b>WARNING</b>
	<p>No user serviceable parts inside. Refer servicing to qualified service personnel.</p> <p style="text-align: right; font-size: small;">011_051514</p>

	 <b>CAUTION</b>
	<p>THE FOLLOWING SECTIONS OF THIS MANUAL ARE INTENDED ONLY FOR QUALIFIED SERVICE PERSONNEL WHO ARE FAMILIAR WITH ELECTRICAL EQUIPMENT. THESE ARE NOT INTENDED FOR THE OPERATOR.</p> <p style="text-align: right; font-size: small;">027_010914</p>

	 <b>CAUTION</b>
	<p>THE FOLLOWING SECTIONS OF THIS MANUAL ARE INTENDED ONLY FOR QUALIFIED SERVICE PERSONNEL WHO ARE FAMILIAR WITH GAS EQUIPMENT. THESE ARE NOT INTENDED FOR THE OPERATOR.</p> <p style="text-align: right; font-size: small;">027b_051514</p>



---

## ORDERING SPARE PARTS

1. Identify the needed part by checking it against the photos, illustrations, and/or parts list. (General images may be used in manual for reference only.)
2. Use only approved replacement parts when servicing this unit.
3. When ordering, please include part number, part name, and quantity needed.
4. Please include your model number, serial number, and date of manufacture (located on the machine nameplate/data plate) with your order.
5. Address all parts orders to:

Parts Department  
Gold Medal Products Co.  
10700 Medallion Drive  
Cincinnati, Ohio 45241-4807

Or, place orders by phone or online:

Phone: (800) 543-0862  
(513) 769-7676  
Fax: (800) 542-1496  
(513) 769-8500  
E-mail: [info@gmpopcorn.com](mailto:info@gmpopcorn.com)  
Web Page: [gmpopcorn.com](http://gmpopcorn.com)





# Kettle Assembly Cross Section – Parts Breakdown

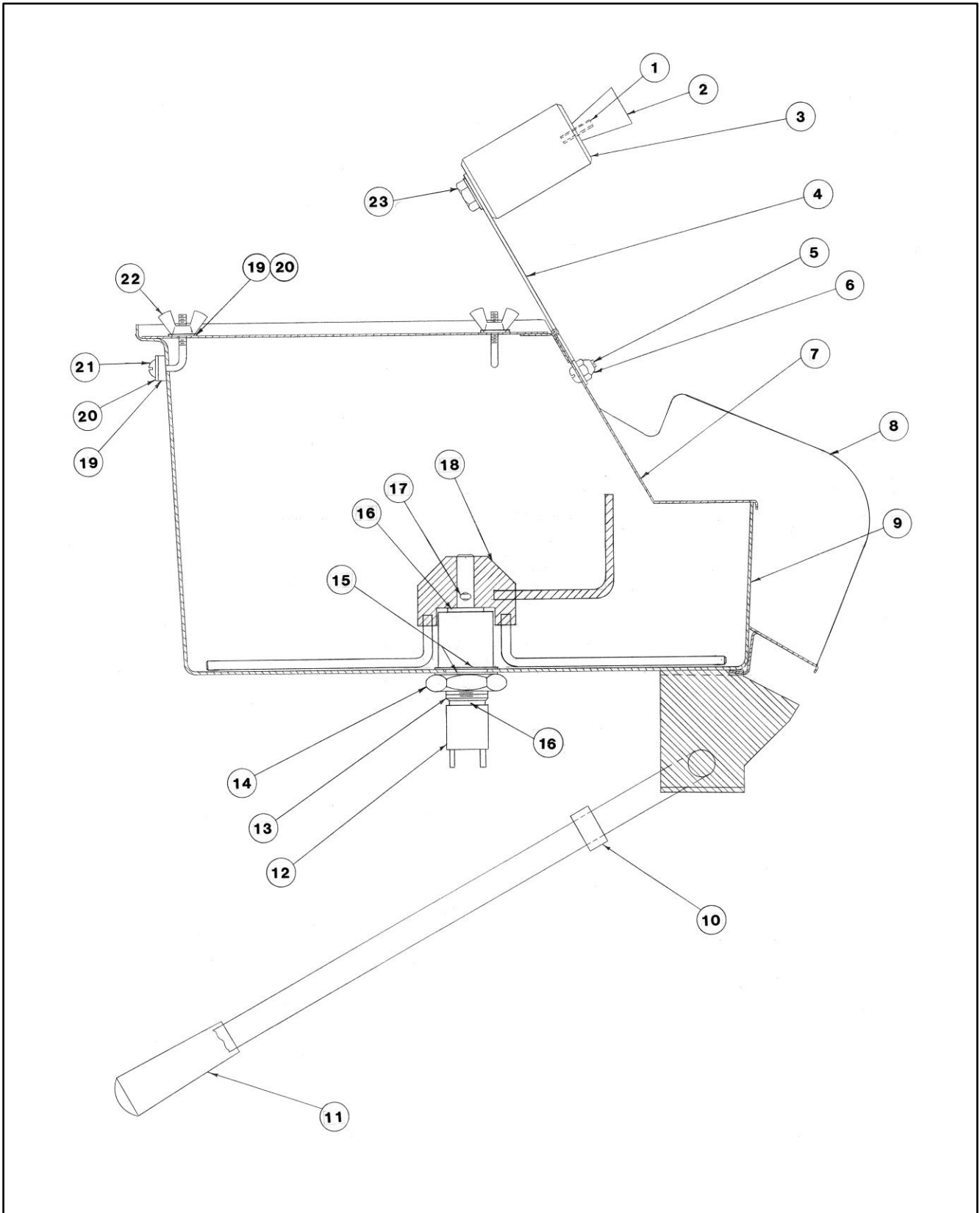



## Kettle Assembly Cross Section – Parts List

Item	Part Description	Part No.
		All Models
1	SET SCREW, #8-32 X	74571
2	KNOB, LID LIFT	47120
3	COUNTER WEIGHT, WITH #8-32 TAP	82108
4	COUNTER WEIGHT BAR, 14 OUNCE	74529
5	SCREW, #8-32 X ½" RD. HD. PH.	74147
6	HEX NUT, #8-32 ESLOK	74146
7	LID ASSEMBLY, WELDED	74545
8	DUMP CHUTE	74546
9	KETTLE WITHOUT AGITATOR AND LID	74504
10	1/2 IN I.D. SPLIT COLLAR	69815
11	DUMP HANDLE, PLASTIC	41139
12	DRIVE SHAFT ASSEMBLY	74512
13	KETTLE BEARING HUB ASSEMBLY	74513
14	NUT, HEX JAM 3/4-16	74553
15	WASHER, COPPER 3/4" I.D.	74555
16	THRUST WASHER, BRONZE	74554
17	COTTER PIN	86573
18	AGITATOR ASSEMBLY	74527
19	SEAL, LID HOLD DOWN SCREW	74088
20	FLAT WASHER, #8	74117
21	SCREW, LID HOLD DOWN	74001
22	WING NUT, #10-24 NYLON INSERT	74118
23	HEX HEAD BOLT, ¼-20 X ¾"	74520
<b>Items Not Shown</b>		
	KETTLE ASSEMBLY, COMPLETE	74505
	SPRING PIN, 1/8" X 3/4"	74552
	SHAFT, EXTENSION	74510



# Pedestal Assembly – Parts Breakdown

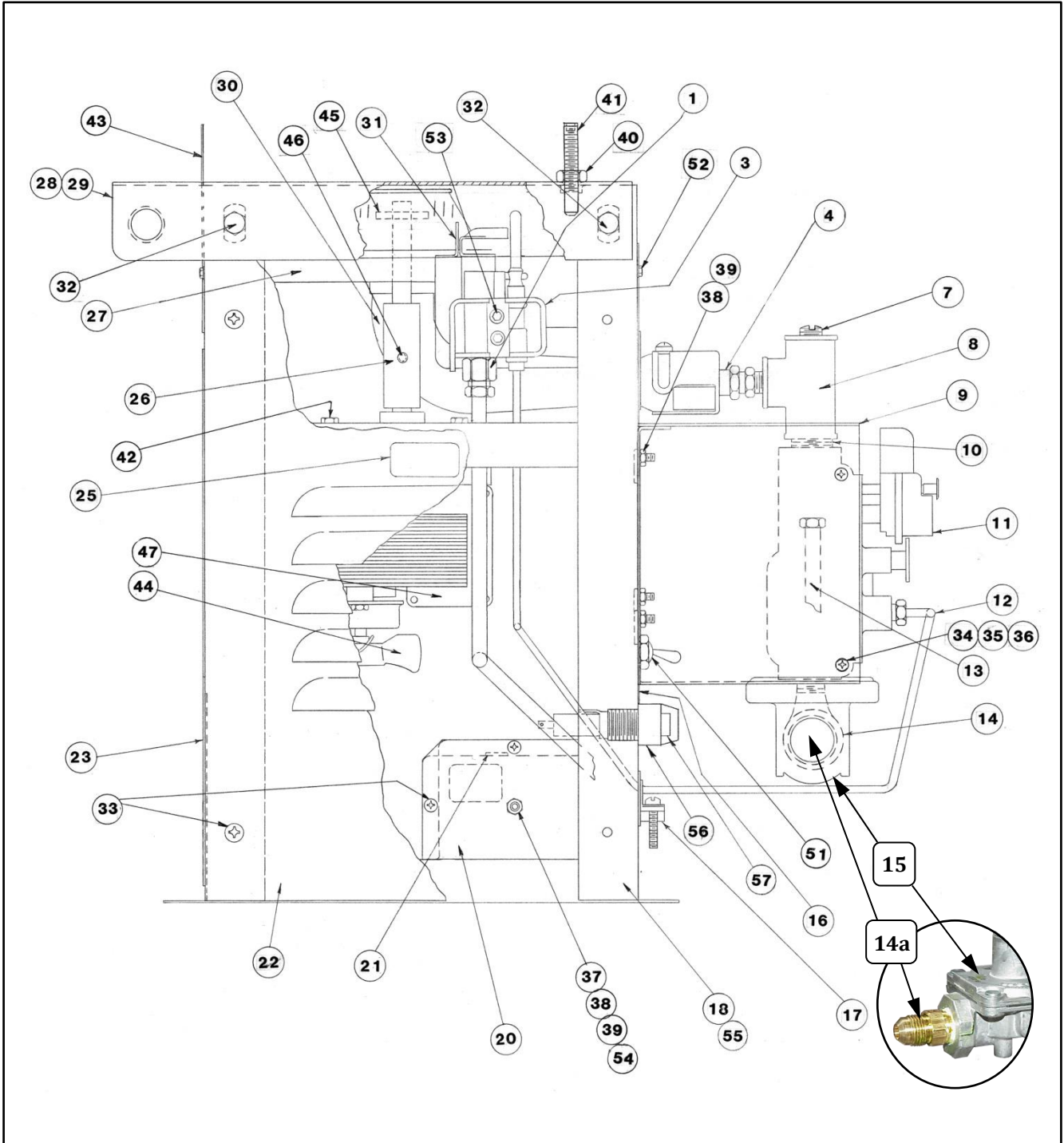



## Pedestal Assembly – Parts List

Item	Part Description	Part Number		
		2035BG	2035EX	2035DC
1	PILOT ORIFICE .011 LP	74029	74029	74029
2	N/A			
3	PILOT BURNER	57031	57031	57031
4	HOOD, ORIFICE #61 LP	74629	74629	74629
5	N/A			
6	N/A			
7	BRASS PIPE PLUG, 1/8" NPT	74562	74562	74562
8	T-FITTING	74560	74560	74560
9	MOUNTING BRACKET REGULATOR	74536	74536	74536
10	3/8" CLOSE NIPPLE	74559	74559	74559
11	GAS SAFETY VALVE	74027	74027	74027
12	THERMOCOUPLE	57030	57030	57030
13	1/4" ALUM. TUBE, 18" LONG	74561	74561	74561
14	3/8" BRASS STREET ELL	74036	74036	74036
14a	ADAPTER, GAS LINE 3/8 NPT (Flare Pipe Fitting, use with Gas Hose P/N 109000)	74595	74595	74595
15	PRESSURE REGULATOR	74115	74115	74115
16	LABEL, LIGHTING INSTRUCTION	74120	74120	74120
17	STRAIN RELIEF, T & B #3302	89045	89045	89045
18	MIGHTY-MITE PEDESTAL WELD	74543	74543	74638
20	FRONT COVER JUNCTION BOX	74519	74519	74519
21	BUSHING, SNAP #SB-500-6	47236	47236	47236
22	FRONT COVER PLATE	74538	74538	74538
25	LABEL, WARNING DISC. POWER	74119	74119	74119
26	EXTENSION SHAFT ASSEMBLY	74551	74551	74551
27	MOUNT PLATE, BURNER	17353	17353	17353
28	DUMP BAR MOUNTING BRACKET, L. SIDE	74532	74532	74532
29	DUMP BAR MOUNTING BRACKET, R. SIDE	74535	74535	74535
30	BURNER FOR 16 OZ.BG POPPER	67903	67903	67903
31	SHIELD, PILOT BURNER	74515	74515	74515
32	HEX HEAD BOLT, 1/4-20 X 3/4"	74520	74520	74520
33	SCREW, #8-32 X 3/8" RD. HD. PH.	74141	74141	74141
34	HEX NUT, #10-32	74143	74143	74143
35	SCREW, #10-32 X 1 1/2" RD. HD. PH.	74145	74145	74145
36	WASHER, #10 INTERNAL TOOTH	42302	42302	42302
37	SCREW, #8-32 X 1/2" RD. HD. PH.	74147	74147	74147
38	WASHER, #8 INTERNAL TOOTH	74150	74150	74150
39	HEX NUT, #8-32	74149	74149	74149
40	HEX NUT, 1/4-20	74133	74133	74133
41	SET SCREW, 1/4-20 X 1 1/2"	42153	42153	42153
42	HEX HEAD BOLT, #10-24 X 3/4"	74136	74136	74136
43	SHIELD, HEAT	74530	74530	74530
45	SPRING PIN, 1/8" X 7/8"	46566	46566	46566
46	SET SCREW #10-24 X 1/2"	42070	42070	42070
47	KETTLE MOTOR, 120V	47038		
	KETTLE MOTOR, 230V		47067	
	12 VOLT DC MOTOR			74576
51	SWITCH, TOGGLE	47201	74087	47201
52	SCREW, #8-32 X 1/2" RD. HD. PH.	74147	74147	74147
53	SCREW, #8-32 X 1" HEX HD.	74153	74153	74153
54	GROUND LUG	74633	74633	74633
	FUSEHOLDER, MIGHTY MITE (not shown)			74636
	FUSE 2.5 AMP (not shown)			74637



## Accessories

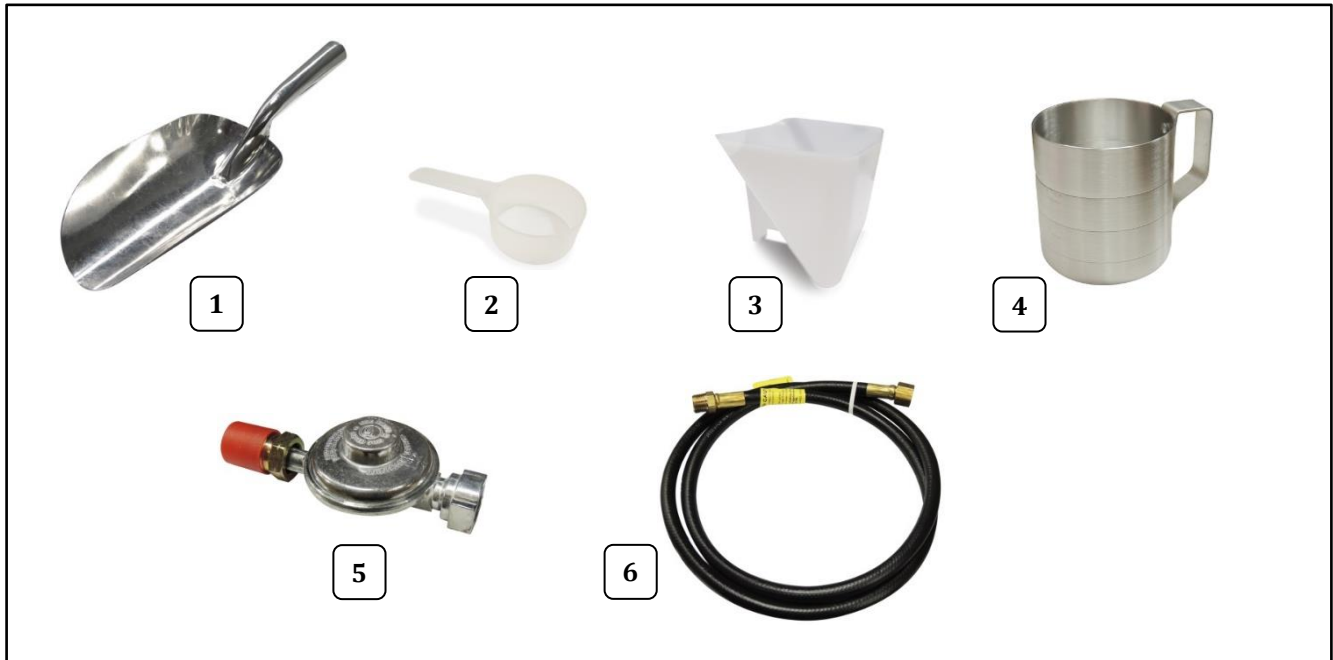

Item	Part Description	Part No.
1	STAMPED ALUMINUM SCOOP	2071
2	MEASURE 20 CC	47680
3	MEASURE 6 OZ.	49049
4	16 OZ CORN MEASURE W/HANDLE	68050
5	TANK REGULATOR	89920
6	GAS HOSE (has a Flared Hose Fitting)	109000





# Model No. 2035DC

**CAUTION - DO NOT USE FUSE  
LARGER THAN 2 1/2 AMP FOR  
MOTOR PROTECTION.**

**FIELD WIRING - - - - -  
INTERNAL WIRING - - - - -**

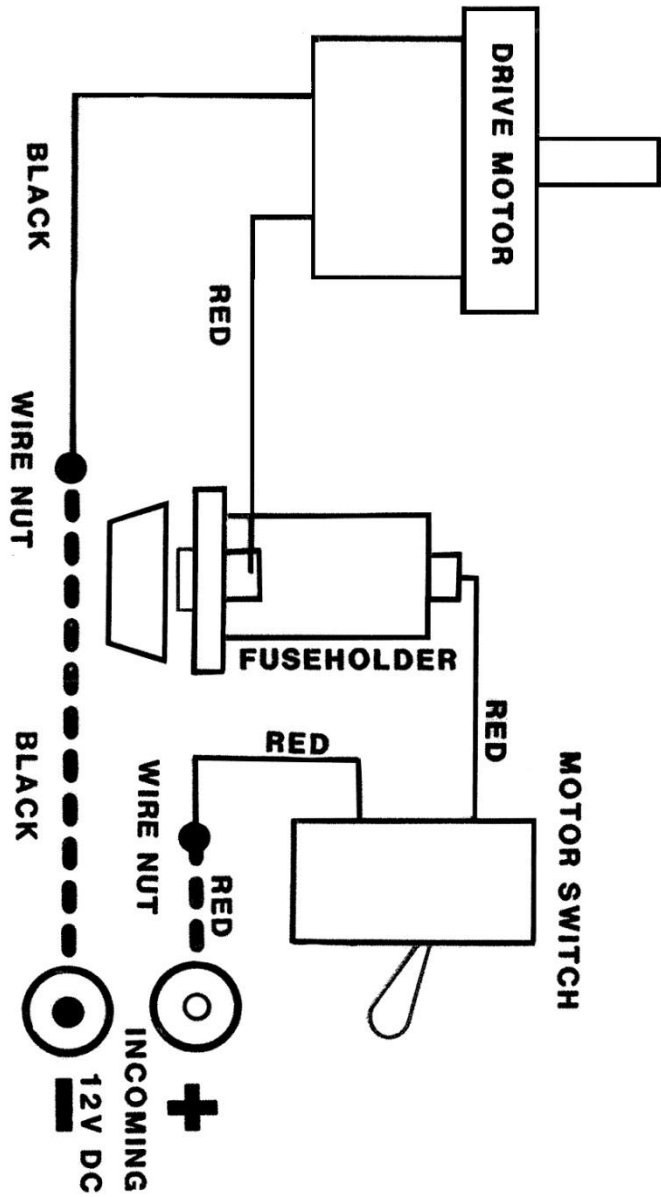

**Note: FIELD WIRING - Red and Black Power Supply Wires  
are to be furnished by customer.**



## WARRANTY

Gold Medal Products Co. warrants to the original purchaser each item of its manufacture to be free of defects in workmanship and material under normal use and service. Gold Medal Products Co.'s obligation under this warranty is limited solely to repairing or replacing parts, f.o.b. Cincinnati, Ohio, which in its judgment are defective in workmanship or material and which are returned, freight prepaid, to its Cincinnati, Ohio factory or other designated point. Except for "Perishable Parts" on specific machines, the above warranty applies for a period of two (2) years from the date of original sale to the original purchaser of equipment when recommended operating instructions and maintenance procedures have been followed. These are packed with the machine. Parts warranty is two (2) years, labor is six (6) months.

THIS WARRANTY IS IN LIEU OF ALL OTHER WARRANTIES EXPRESSED OR IMPLIED, AND OF ALL OTHER OBLIGATIONS OR LIABILITIES ON OUR PART, INCLUDING THE IMPLIED WARRANTY OF MERCHANTABILITY. THERE ARE NO WARRANTIES WHICH EXTEND BEYOND THE DESCRIPTION ON THE FACE HEREOF. In no event shall Gold Medal Products Co. be liable for special, incidental or consequential damages. No claim under this warranty will be honored if the equipment covered has been misused, neglected, damaged in transit, or has been tampered with or changed in any way. No claim under this warranty shall be honored in the event that components in the unit at the time of the claim were not supplied or approved by Gold Medal Products Co. This warranty is effective only when electrical items have been properly attached to city utility lines only at proper voltages. This warranty is not transferable without the written consent of Gold Medal Products Co.

The term "Original Purchaser" as used in this warranty shall be deemed to mean that person, firm, association, or corporation who was billed by the GOLD MEDAL PRODUCTS CO., or their authorized distributor for the equipment.

THIS WARRANTY HAS NO EFFECT AND IS VOID UNLESS THE ORIGINAL PURCHASER FIRST CALLS GOLD MEDAL PRODUCTS CO. AT 1-800-543-0862 TO DISCUSS WITH OUR SERVICE REPRESENTATIVE THE EQUIPMENT PROBLEM, AND, IF NECESSARY, FOR INSTRUCTIONS CONCERNING THE REPAIR OR REPLACEMENT OF PARTS.

*NOTE: This equipment is manufactured and sold for commercial use only.*



**GOLD MEDAL PRODUCTS CO.**

10700 Medallion Drive, Cincinnati, Ohio 45241-4807 USA

[gmpopcorn.com](http://gmpopcorn.com)

Phone: (800) 543-0862      Fax: (800) 542-1496  
(513) 769-7676              (513) 769-8500